

# Detached Houses and Low Rise Multi-Residential Floors

Design and Installation Guide



# Contents

This Design Guide has been prepared as a source of information to provide general guidance to consultants – and in no way replaces the services of the professional consultant and relevant engineers designing the project.

It is the responsibility of the architectural designer and engineering parties to ensure that the details in this Design and Installation Guide are appropriate for the intended application.

The recommendations of this guide are formulated along the lines of good building practice, but are not intended to be an exhaustive statement of all relevant data.

## **Introduction** **3**

### **1. Design and selection details** **6**

- How to use this design and Installation Guide 6
- System components 8
- Design considerations 10
- Architectural Specification 11

### **2. System performance** **14**

- System properties 14
- Building regulations 16

### **3. Installation detail** **18**

- Hebel PowerFloor installation sequence 18
- Construction details 19
- Hebel PowerFloor panel fixing details 24
- Control joint details 26
- Multi-Level Construction details 29
- Hold-down/bracing wall details 30
- Penetrations & notching details 31
- Wet area detail 31
- Balcony & staircase details 32
- Floor covering installation 33
- Tile installation 34
- Vinyl installation 34
- Timber installation 35

### **4. Handling, storage and responsibility** **36**

- Delivery and storage 36
- Tools and equipment for construction 37
- Panel installation 38
- Panel handling 39

### **Appendices** **40**

- A1. Hebel PowerFloor panel material properties 40
- A2. Estimating Hebel PowerFloor 41

# Better floors are constructed with Hebel PowerFloor



Hebel is a lightweight steel-reinforced Autoclave Aerated Concrete (AAC) that has been used in Europe for over 70 years and here in Australia for over 20 years.

## **Hebel. A high-performance lightweight concrete flooring system**

Hebel PowerFloor is high-performance lightweight concrete flooring system ideal for installation over timber or steel joists.

This system provides a superior floor solution with the qualities and feel of a concrete floor at a significantly reduced cost. Each Hebel PowerFloor panel is reinforced with corrosion-protected steel mesh and panels fit snugly together to form a strong, solid and smooth floor for just about any floor covering.

Hebel PowerFloor can be easily installed by your normal on-site tradesmen such as carpenters and is unaffected by wet or changing weather during installation and, unlike concrete, without the need for curing or propping.

## **Hebel. Supreme comfort, solid and low noise emitting**

The Hebel PowerFloor system reduces foot-fall, airborne noise between floors and eliminates squeaking that is often the case with particle board flooring.

PowerFloor boasts superior thermal performance (particularly for suspended floors on sloping sites) and assists in achieving thermal ratings that result in reduced heating and cooling costs.

## **Proven in the market and Australian made by CSR**

Hebel is 100% manufactured in Australia by CSR Building Products Limited, so you can depend and rely on the product quality, technical expertise, warranty and stock supplies. With CSR you can trust that everything has been proven, tested and continually improved.



HEB-2006  
GECA 08-2005—  
Environmentally  
Innovative Products

# Hebel PowerFloor. Better to build

At the heart of the Hebel system is the Hebel PowerFloor – a 75mm thick, steel reinforced building panel made from AAC (Autoclaved Aerated Concrete) supplied in a length 1800mm by 600mm wide with a tongue and groove profile.

The unique Hebel attributes are best summarised with the Hebel 'tick' below:



## Faster construction period

Hebel PowerFloor is faster to construct than suspended concrete. No propping and curing of concrete is required. Typical placement rates of 70m<sup>2</sup> per day can be achieved with follow on trades starting after 24 hours.



## Lightweight yet solid and tough as concrete

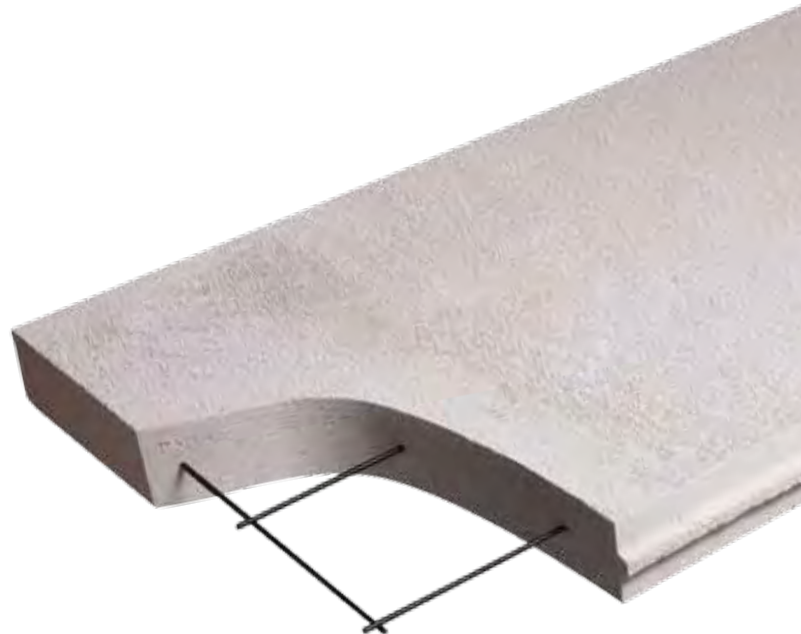
Being a masonry, steel reinforced 75mm thick panel, Hebel PowerFloor is solid and strong. A lightweight concrete floor that can be easily laid by your normal on-site tradesmen such as carpenters.



## A comforting thought for a comfortable living environment

Hebel's unique AAC construction provides superior insulation qualities for a masonry product. The unique combination of thermal resistance along with thermal mass, make building with Hebel a smart choice for meeting Australia's stringent building regulations.

For unit and home owners, the thermal efficiencies of Hebel reduce the reliance on heating and cooling appliances – the combined effects of using a heater less in winter and fans or air conditioning less in summer and warmer months can have a big impact on rising energy costs.



# with...



### Highly fire resistant for peace of mind and added security

Hebel is non-combustible and renowned for its highly fire resistant properties. The PowerFloor System achieves a FRL (Fire Resistance Levels tested at CSIRO) from 60 minutes below (with Relevant CSR Gyprock ceiling) through to 240 minutes from above.



### A sound reason for better acoustic qualities

Hebel PowerFloor answers the age old issue of sound transfer between floors. Creaking timber is a thing of the past as the tongue and groove solid concrete floor locks together. PowerFloor provides superior airborne noise insulation particularly good for foot fall noise when installed with resilient mounts. With home theatres becoming standard in most modern homes, you can enjoy your entertainment without disturbing the rest of the family.



### Sustainability for a better world in the long term starts today

Hebel delivers a diverse number of environmental benefits over particle board and concrete. In an independent Life Cycle Assessment (the leading methodology used to quantify the environmental impacts of a product's entire life) undertaken by Good Environment Choice Australia, in accord with international standard ISO 14 024, Hebel was found to have clear environmental benefits across all key environmental criteria.

To be awarded the label, products must have a 30% lower impact than alternatives. Hebel uses 64% and 43% less greenhouse gas emissions than the comparative products, concrete and particle board flooring.

As environmental consciousness and social responsibility increases, Hebel is striving to exceed further to set new sustainability standards in building materials and residential living.

## ...for all the best reasons

Wherever it is applied, Hebel provides a highly desirable and attractive, distinctive finish, while affording a hard working combination of acoustic suppression, fire resistance and security and is recognised as one of the most flexible building systems.



# 1.1 Design

## Typical Applications

Hebel PowerFloor systems detailed in this design and installation guide are joist floor solutions for detached residential, low rise multi-residential, commercial and industrial construction. The floor applications consist of a Hebel PowerFloor panel connected to a steel or timber joist system forming a platform floor.

Figures 1.1, 1.2, 1.3 show typical applications for Hebel PowerFloor, for more details refer to Hebel Technical Update TU-009.

*Fig 1.1 Residential Suspended Ground Floors*



*Fig 1.2 Residential Suspended First Floors*



*Fig 1.3 Commercial Floors - schools, offices and community centres*



# 1.2 How to use this Design and Installation Guide

## Systems Index - Table 1.4

This allows the designer to quickly locate a system that combines the acoustic rating ( $R_w$ ), approximate floor thickness (excluding joist height), floor covering type and ceiling system requirement.

## System Components, System Properties & Design Considerations

These sections provide relevant background information to enable designers to plan and select appropriate Hebel PowerFloor systems.

## Hebel PowerFloor System Pages

These pages provide detailed performance information to assist in the selection of an appropriate Hebel PowerFloor system for the application under consideration.

## Architectural Specification

This material can be copied for inclusion onto working drawings or project specifications. This provides a pro-forma layout with fill in sections to quickly and easily create and customise project specifications.

## Installation Diagrams and Fixing Instructions

General design and installation information is provided for the various systems available. For more detailed information contact your CSR Hebel representative. For further information on different joist types and their applications, please contact the joist manufacturer.

## Selecting a system

**STEP 1.** Scan the 'System Index' for systems with the appropriate floor covering for the intended application.

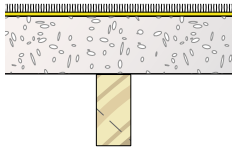
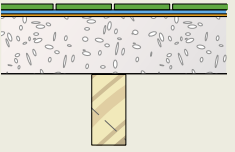


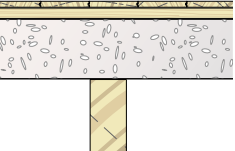
**STEP 2.** Turn to the selected system page and select ceiling system that provides appropriate performance (FRL/R<sub>w</sub>/R-Value).

**STEP 3.** Consult your chosen structural engineer to determine a joist size and spacing requirement.

**STEP 4.** Confirm structural adequacy. Contact the joist manufacturer, or your chosen structural engineer.

**STEP 5.** Confirm acoustic and thermal performance by contacting the appropriate project engineer.

*Table 1.4 System index for CSR Hebel PowerFloor Systems*

Hebel PowerFloor System Description	Floor Covering Type	Applications & Benefits	System N <sup>o</sup>	System Details Page N <sup>o</sup>
	<ul style="list-style-type: none"> <li>• Carpet</li> <li>• Medium duty underlay</li> </ul>	<ul style="list-style-type: none"> <li>• Carpeted floor with a high level thermal performance.</li> </ul>	Hebel 1600-1604	19
	<ul style="list-style-type: none"> <li>• 8mm Ceramic tiles</li> <li>• Flexible adhesive</li> <li>• Waterproof membrane (not required in dry areas)</li> </ul>	<ul style="list-style-type: none"> <li>• Rigid floor system, with good thermal performance. Suitable for wet or dry areas.</li> </ul>	Hebel 1605-1609	22
	<ul style="list-style-type: none"> <li>• 8mm Ceramic tiles</li> <li>• Flexible adhesive</li> <li>• Concrete topping slab</li> <li>• Waterproof membrane</li> </ul>	<ul style="list-style-type: none"> <li>• Wet area applications where a finished level has to be built-up and/or a surface fall is required.</li> </ul>	Hebel 1610-1614	23
	<ul style="list-style-type: none"> <li>• Vinyl sheet floor covering</li> <li>• Masonite underlay</li> </ul>	<ul style="list-style-type: none"> <li>• Inexpensive floor with a hard surface and high level of thermal performance.</li> </ul>	Hebel 1615-1619	20
	<ul style="list-style-type: none"> <li>• 19mm T&amp;G hardwood flooring</li> <li>• 70 x 35mm timber battens</li> </ul>	<ul style="list-style-type: none"> <li>• Attractive solid timber finish with a high level of thermal performance.</li> </ul>	Hebel 1620-1629	21

*Note: Resilient mounts will help reduce footfall noise when using hard surface coverings such as tiles.*

# 1.3 System Components

## These components are compatible with timber and steel joists.

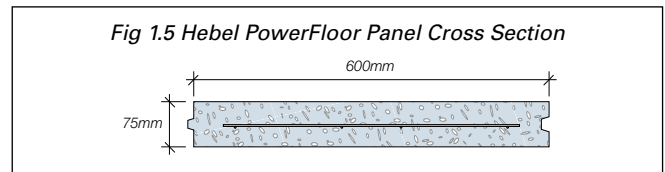
- Hebel PowerFloor Panel
- Floor Covering
- Proprietary Ceiling System
- Hebel Adhesive
- Fuller® Max Bond™
- Fasteners & Fixings
- Caulking

CSR Building Products Limited, guarantees only the products that are manufactured by CSR Hebel, not the components, products or services supplied by others.

## Hebel PowerFloor Panel

The Hebel PowerFloor panel is available in a stock length of 1800mm x 600mm width, with a mass of up to 56kg/panel. Where necessary, panels can be cut on-site using a circular saw with diamond tipped cutting blade. The minimum recommended width of a cut panel is 270mm width and 900mm in length.

The panels are screw fixed and bonded to all floor joists except at panel butt joints. At butt joints, panels are fixed using two beads of adhesive, and the screws may be omitted. For further information on fixing Hebel PowerFloor panels, please refer to relevant construction details outlined in this guide.



Ceiling System Description	Ceiling System Components
a) CSR821 	<ul style="list-style-type: none"> <li>• CSR Resilient Mounts (N° CSR1) screw fixed to every joist at 600mm maximum centres.</li> <li>• RONDO Furring Channel (N° 129) at 600mm maximum centres, clipped into resilient mounts.</li> <li>• Bradford Glasswool Gold Batts R2.0 insulation infill.</li> <li>• 1 layer x 13mm GYPROCK Plasterboard CD fixed to furring channel.</li> </ul>
b) CSR 826 	<ul style="list-style-type: none"> <li>• CSR Resilient Mounts screw fixed to every joist at 600mm centres.</li> <li>• RONDO Furring Channel (N° 129) at 600mm maximum centres, clipped into resilient mounts.</li> <li>• 105mm Bradford Gold Insulation R2.0 GW insulation batts.</li> <li>• 1 layer x 16mm GYPROCK FYRCHEK Plasterboard CD fixed to furring channel.</li> </ul>
c) CSR 827 	<ul style="list-style-type: none"> <li>• CSR Resilient Mounts screw fixed to every joist at 600mm centres.</li> <li>• RONDO Furring Channel (N° 129) at 600mm maximum centres, clipped into resilient mounts.</li> <li>• Bradford Glasswool Gold Batts R2.0 insulation infill.</li> <li>• 2 layers x 16mm GYPROCK FYRCHEK Plasterboard CD fixed to furring channel.</li> </ul>



## Floor Coverings

A range of floor coverings can be installed over the Hebel PowerFloor panels, such as, direct stick tiles, carpet and underlay, topping slab and tiles, timber (floating or on battens) and vinyl over masonite.

## Proprietary Ceiling Systems

The underside of Hebel PowerFloor can be lined with proprietary ceiling systems. These ceiling systems consist of combinations of components, such as furring channel, resilient mounts, clips, suspended steel framing, insulation, and plasterboard.

The most common combinations are detailed in the table on the opposite page.

Further information on floor/ceiling systems is available through CSR Gyprock, or the publications, CSR Gyprock Fibre Cement Fire & Acoustic Design Guide ('The Red Book™'), N°GYP500, and CSR Gyprock Ceiling Systems Installation Guide, N°GYP570.

## Timber & Steel Support Systems

Timber or steel floor framing can be used to support the Hebel PowerFloor panels. The allowable spacing of the joists is 450mm or 600mm only. The joists, bearers and other supports shall be sized in accordance with the framing manufacturer's recommendations. Where steel joist framing is used it must be ensured that the PowerFloor panels are provided with uniform and complete bearing onto each steel joist.

*Note: The designer should allow at least 51kg/m<sup>2</sup> for the selfweight of the Hebel PowerFloor panel. A minimum joist flange width of 45mm is required.*

## Hebel Adhesive

Hebel Adhesive (supplied in 20kg bags) is used for gluing the panels together at all joints. Typically, panel joints are 2-3mm thick. Sufficient pressure is to be applied to the joint to ensure full coverage of adhesive in the joint. Adhesive is to be mixed to the proportions as stated on the bag.

## Construction Adhesive

A 5mm (minimum) bead of Fuller Max Bond construction adhesive is applied to the top of the joists. Where panel ends butt together over a common joist, two beads of adhesive shall be applied. Ensure the surface is free of coatings and loose material that may inhibit bond.

## Fasteners

The correct sized fasteners for the construction of the floor systems must always be used. Install screws as shown in the Hebel PowerFloor Panel Fixing Details section of this guide.

### Screws for fixing Hebel PowerFloor panels to

**Timber Joists:** 14-10 x 100mm MP Bugle Head Batten Screws or equivalent.

### Screws for fixing Hebel PowerFloor panels to

**Steel Joists:** 14-10 x 95mm Hex Head Self-tapping Screws or equivalent (no seal required). This fastener is suitable for metal thickness <3mm. Refer to screw manufacturer's guidelines.



## Caulking

Hebel PowerFloor requires that all gaps at openings, penetrations and control joints be caulked to provide an airtight floor system that maintains acoustic, thermal, vermin and fire resistance performance. All gaps must be carefully and completely filled with an appropriate flexible polyurethane sealant, installed in accordance with the sealant manufacturer's specifications.

## Hebel Patch

Minor chips or damage to panels are to be repaired using Hebel Patch. Hebel Patch is available in 10kg bags.



## Hebel anti-corrosion protection paint

Reinforcement exposed when panels are cut shall be coated with a liberal application of Fentak.

# 1.4 Design Considerations

## Acoustics

Placement of insulation in the ceiling cavity can enhance the sound insulation performance of a floor/ceiling system.

A carpet/underlay floor covering incorporated with Hebel PowerFloor will provide the best impact sound resistance. For hard surface floor coverings, we suggest using a floating floor and/or an independent ceiling system, incorporating resilient mounts or resilient furring channels.

For ceilings that incorporate resilient mounts or resilient furring channels, flanking sound paths through adjacent walls are common, especially in timber framed buildings. To maintain  $R_w$  and IIC ratings, the wall linings may also need to be resiliently mounted. For multi-tenancy buildings, providing a control joint at the party wall will break a flanking path and maintain acoustic amenity.

## Alternative Framing

Alternative support framing systems including steel, and composite steel/timber joists, laminated timber joists, and trussed plywood web joists may be used without reducing the system FRL rating for a fire source 'from above'. The design of joists shall allow for temperature effects. Alternative support framing systems may affect acoustic performance, and advice from an acoustic consultant is recommended.

## Penetration Restrictions

Penetrations are required to accommodate services, such as waste pipe-work, water pipe-work, and air conditioning ductwork, etc. Hebel PowerFloor can accommodate an 80mm maximum circular penetration without a reduction in structural performance. Multiple penetrations in the same panel are to be in a straight line, parallel to the long edge of the panel.

For large or clustered multiple penetrations, additional joists or bridging should be included for support of the panel in this area. Refer to the 'Penetration & Notching Details' section of this guide. All penetrations are a potential source for water ingress or air leaks, and should be sealed with an appropriate flexible fire rated sealant or proprietary collar.

## Control Joint Layout

Control joints are a necessary part of Hebel PowerFloor. Control joints provide a region in which to relieve stress due to movement of the structural system, and to control the location where movement can occur without a detrimental effect on the floor finish.

Recommended locations for control joints are:

- Typically at a max. spacing of 6000mm.
- Over lines of support for the joists. Refer to Fig 3.10.
- Located at lines of bracing, ensuring a diaphragm between the bracing lines
- Located at changes in joist orientation.

## Wet Area Floor Construction

All wet areas require a waterproof membrane layer over the Hebel PowerFloor panel. Waterproofing membranes shall be nominated by the designer or specifier, and installed in accordance with manufacturer's recommendations.

## Serviceability Behaviour

The deflection limits of the floor are governed by the adopted joist size. As a guide, the following typical deflection limits provide acceptable behaviour and dynamic response:

- Dead Load (DL): span/300 or 12.5mm max.
- Live Load (LL): span/360 or 9mm max.
- DL & LL: span/400.
- Dynamic Response: 2mm max. under a 1kN point load.

## Concentrated Loads

For concentrated loadings, such as a loadbearing wall or point loads, the designer should ensure additional joists or blocking are provided beneath the wall or bearing plate. This will reduce the localised bearing stress. Bearing stress in the AAC shall be limited to 1.0MPa.

*Note: The designer should select appropriate deflection limits to suit individual projects.*

## Bracing Walls

For bracing walls parallel to joists, a joist shall be positioned beneath the wall. For bracing walls perpendicular to joists, blocking shall be positioned beneath the wall. Blocking shall have a minimum width of 45mm. Bearing stress in the AAC shall be limited to 1.0MPa.

## Panel Support

All Hebel PowerFloor panels are to start and finish on a joist. Panels must be joined on a joist.

# 1.5 Architectural Specification

This specification should be adopted as a guide only, and shall be superseded by the contract specifications of the project.

*\* Insert or select appropriate specifications.*

## Scope

The contractor shall furnish all material and equipment required to satisfactorily complete the installation and jointing of Hebel PowerFloor where indicated in the contract specification.

## Materials

All AAC material shall be a Hebel PowerFloor panel as manufactured by CSR Hebel.

All accompanying fixings shall be those supplied by CSR Hebel or approved by the project engineer.

All lining materials shall be Gyprock plasterboard as manufactured and supplied by CSR Gyprock (or products of equivalent or better performance). All plasterboard shall be manufactured to meet the dimensional requirements of AS/NZS2588 'Gypsum Plasterboard'.

Steel frame components shall be those manufactured by Rondo Building Services Pty Ltd (or products of equivalent or better performance).

Construction adhesive shall be Fuller Max Bond as manufactured and supplied by Fuller (or products of equivalent or better performance).

All sealants shall be a polyurethane type with required fire and acoustic ratings, (or products of equivalent or better performance).

All infill materials shall be products manufactured and supplied by CSR Bradford® (or products of equivalent or better performance).

## Hebel PowerFloor System

The contractor shall supply and install a Hebel PowerFloor system \*PF-.....(....), in accordance with CSR Hebel Detached Houses & Low Rise Multi-Residential Floor Design Guide, N°HBLA185, and CSR Gyprock Fibre Cement Fire & Acoustic Design Guide ('The Red Book™'), N°GYP500, and shall satisfy the following performance criteria.

The Hebel PowerFloor system shall have a Fire Resistance Level of \*FRL.../.../... for a fire source 'from above' in accordance with the requirements of AS1530.4. Design of the joists shall allow for temperature effects.

Installation shall be carried out to the level specified for a field acoustic performance of \*Dntw..... using cavity infill of \*Bradford ..... (or products of equivalent or better performance).

## Levels of Finish - Floor Covering

Prior to installation of the floor covering, the contractor shall ensure the installed panels are within the tolerances of the project specifications.

The contractor shall ensure that all control joints are installed as per project specifications, panel joints are completely filled with Hebel Adhesive, minor chipping damage of the panels shall be patched with Hebel Mortar, and all sealants are installed as per manufacturer's specifications.

Floor coverings shall be installed as per manufacturer's specifications, unless specified otherwise in the contract documentation.

## Ceiling System

The contractor shall supply and install the Gyprock Ceiling System \*N°CSR..... in accordance with CSR Gyprock Fibre Cement Fire & Acoustic Design Guide ('The Red Book '), N°GYP500. The ceiling framing shall be lined with \*..... layers of..... mm Gyprock..... plasterboard.

## Levels of Finish - Ceiling Systems

All ceiling framing systems, plasterboard lining, jointing and finishing shall be carried out to \*Level ..... Level of Finish, in accordance with CSR Gyprock Plasterboard Residential Installation Guide, N°GYP547, AS/NZS2589.1 'Gypsum Linings in Residential and Light Commercial Construction - Application and Finishing'.

## Plasterboard

The Hebel PowerFloor system ceiling framing shall be lined with \*..... layer/s of .....mm Gyprock ..... plasterboard.

## Plasterboard fixing

All layers shall be fixed to the framing (ie., timber or steel floor joists and/or steel furring channels) as specified for the relevant system in the CSR Gyprock Ceiling Systems Installation Guide, N°GYP570, other relevant CSR Gyprock technical literature, and Rondo Building Services Pty Ltd literature or steel frame manufacturer's literature.

## Jointing & Finishing

Jointing and finishing of the outer layer of plasterboard shall be in accordance with the CSR Gyprock Plasterboard Residential Installation Guide, N°GYP547.

## Caulking

Where caulking is indicated in fire rated systems \*..... fire rated polyurethane sealant or fire rated backing rod with \*..... acoustic rated polyurethane sealant shall be used, and installed in accordance with the manufacturer's recommendations.

Where caulking is indicated in wet areas, a \*..... polyurethane sealant must be used when caulking \*non-fire rated/fire rated wet areas, as indicated, and installed in accordance with the manufacturer's recommendations.

## Important

Any variation or substitution of materials or assembly requirements, or compromise in assembly may result in failure under critical conditions.

**Note: This information can be downloaded from the CSR Hebel website: [www.hebelaustralia.com.au](http://www.hebelaustralia.com.au)**

# Design notes:

A series of horizontal dotted lines for writing design notes.

# 2.1 System Properties

## Structural Performance

Hebel PowerFloor systems can support a maximum uniformly distributed load of 5kPa, or concentrated (point) load of 1.8kN over a load area of 350mm<sup>2</sup> (with joists at 450mm or 600mm centres only) 3.9kN over a load area of 10,000mm<sup>2</sup>. For loads outside this range, please contact CSR Hebel.

The designer should specify the magnitude of the gaps between the Hebel PowerFloor panel and structure. This gap will allow movement to release any confining stresses due to movement of the supporting structure.

## Durability

Where Hebel PowerFloor is installed in a multi-residential/commercial application, the PowerFloor panels must be suitably protected against trafficability during construction to maintain the long term durability and integrity of the panels. It is the responsibility of the builder to provide and maintain such protective coverings to the PowerFloor panels until such time that the finished floor coverings are installed.

For application of PowerFloor in commercial projects Hebel Technical Services must be contacted for advising on durability and protection of the PowerFloor panels during construction.

## Fire Resistant Levels

Australian building regulations express the fire performance of a floor/ceiling with the rating system called the 'Fire Resistance Level' (FRL). The FRL rating of the systems detailed in this guide are opinions issued by the CSIRO based on test results.

Testing has been conducted in accordance with the Australian Standard AS1530 : Part 4 'Fire Resistance Tests of Elements of Building Construction'.

The FRL rating consists of three performance criteria, structural adequacy/integrity/insulation. For example, the FRL of a floor may be expressed as 180/120/90. Where '180' indicates a rating for 'structural adequacy' of 180 minutes, followed by 'integrity' for 120 minutes, and 'insulation' for 90 minutes. The Hebel PowerFloor system has fire resistance of 240 minutes from a fire source above the floor. For fire resistance to a fire source below the floor a fire rated ceiling system must be installed.

## Acoustic Considerations

### Sound Ratings

Floor systems, consisting of the Hebel PowerFloor and other products, have been laboratory tested to establish their sound insulation characteristics. A laboratory test involves the installation of a system between two massive concrete rooms, which are normally well isolated from one another, so that only direct transmission is via the system.

A steady sound level of various frequencies is generated on one side and measurements taken on both sides. These measurements are made in one-third octave bands from 100Hz to 5000Hz. For each specified frequency, the sound transmission loss is calculated. To assist in communication the performance is conveniently expressed as a single number called the 'Weighted Sound Reduction Index' ( $R_w$ ).

### Weighted Sound Reduction Index ( $R_w$ )

Recently, Australian building regulations have adopted the International Standard Organisation acoustic rating system called the 'Weighted Sound Reduction Index' ( $R_w$ ). The  $R_w$  value replaces 'Sound Transmission Class' (STC) as a measure of the acoustic performance of a wall. A correction figure of  $C_{tr}$  is added to the  $R_w$  value to better quantify the acoustic performance of the building system.

### $C_{tr}$ Adaptation Term

The normal rating of  $R_w$  more closely defines the acoustic performance for speech frequencies. Where low frequency sound insulation performance is important, as may be the case with traffic noise or music and DVD systems, then a correction factor is applied to the airborne sound rating ( $R_w$ ) to differentiate the systems with good sound insulation to these frequencies. The factor is  $C_{tr}$  and it is a negative value. A system with good low frequency performance will have a value of say -4; a system with poor performance will have a value of say -12.

### Impact Isolation Class (IIC)

The 'Impact Isolation Class' (IIC) quantifies the transmission of impact sound through a floor/ceiling system.

The test involves impacting the floor assembly with a standard tapping machine and measuring the sound level below in the same manner as described for the airborne sound insulation. Higher numbers indicate less sound is being transmitted. IIC is an American system and is now being replaced by  $L_{n,w}$ , which is the ISO equivalent.

**Ln,w**

This is the measure of the weighted and adjusted sound level below the floor when the tapping machine is operated above. In this case the lower the value the better the acoustic performance.

There is an approximate relationship between Ln,w and IIC, either can be subtracted from the numerical value of 110 to determine the other.

**C1 Adaptation Term**

The rating by Ln,w appears to work well where carpets or floating floors are employed on concrete or timber framed floors. With hard floor finishes, particularly with timber joist floors, the low frequency performance may require further consideration by your acoustic consultant.

**Test Reports**

All test reports quoted in this guide have been issued by the CSIRO, National Acoustic Laboratory or other NATA Registered Laboratories. Testing has been conducted in accordance with the relevant Australian Standard at the time of testing.

**Sound Transmission Estimates**

Computer models are used to determine sound transmission estimates for specific configurations, known as 'Acoustic Assessments'. The computer model predicts the Rw performance expected from the laboratory test on the system, with a 96% confidence limit of  $\pm 2.5$  db.

**Performance - Laboratory vs Field.**

When selecting the appropriate Hebel PowerFloor system, the designer or specifier must be aware that the laboratory Rw values are always higher than the field measured values (R<sub>w</sub>). This is due to the field conditions, such as flanking paths, air leaks, floor frame construction type and stiffness, etc., which can be introduced by careless building design or construction. To avoid significant reductions in acoustic performance published construction details must be followed completely. Independent specific advice and confirmation should be sought for specific projects where the presence of flanking paths or any other acoustic effect may affect field performance.

Typically, the field performance of a system will be 2 to 5 Rw units lower than the laboratory performance, and allowance should be made for this by the acoustic consultant during the selection of the floor system.

**Thermal Performance**

Thermal performance is concerned with the energy retention or loss characteristics of a building system. One of the primary design objectives in planning a cost effective building is to provide a comfortable living/working environment for the building's inhabitants. Exploiting the inherent thermal qualities of Hebel AAC enables the designer to achieve this objective.

**R-Value Rating**

The energy demand can be minimised by controlling the heat transfer, which is heat flowing from a hot region to a colder region, through a building system. The thermal resistance of a building system is expressed as the R-Value. The R-Value of the system is the sum of the R-Values of the individual components.

**Thermal Masses & Insulation Property**

Several comparative studies have been conducted to investigate the benefits of incorporating Hebel AAC walls in place of conventional wall systems or thermal mass. A common trend was the lower heating and cooling energy consumption and smaller mechanical equipment required to maintain a comfortable living environment, especially with regards to regions of mainly cold weather.

The benefit of thermal mass is that it tends to buffer the effects of external temperature swings. Thermal mass coupled with the insulation quality of Hebel AAC, which impedes the flow of heat through the floor, gives an excellent barrier to a variable outside elements.

**Thermal Integrity**

Poor thermal integrity, due to bad construction practices can also significantly affect the comfort performance, as poor sealing and gaps allow air to infiltrate as drafts. The inherent construction tolerances of Hebel PowerFloor provides a floor with a low infiltration rate and good thermal integrity.

# 2.2 Building Regulations

## Intertenancy Floors

Floors constructed between separate tenancies are required to achieve a minimum acoustic and fire performance.

### Acoustic Performance

For Class 2 and 3 Building with floors separating sole occupancies the following minimum acoustic requirements are described in the BCA:

- Airborne Sound Transmission:

$$R_w + C_{tr} \geq 50$$

- Impact Sound Transmission:

$$L_{n,w} + C_I \leq 62$$

Or, measured in-situ performance of:

- Airborne Sound Transmission:

$$D_{nt,w} + C_{tr} \geq 50$$

- Impact Sound Transmission:

$$L_{nt,w} + C_I \leq 62$$

### Fire Performance

For Class 2 and 3 Building with floors separating sole occupancies the following fire requirements are described in the BCA:

- FRL - 90/90/90 (Structural Adequacy/ Integrity/Insulation)

Please refer to section C of the BCA for certain exemptions to the above fire rating requirements.

## Compliance with the Building Code of Australia (BCA)

All building solutions, such as walls, floors, ceilings, etc. must comply with the regulations outlined in the BCA or other authority.

The BCA is a performance based document, and is available in two volumes which align with two groups of 'Class of Building':

**Volume 1:** Class 2 to Class 9 Buildings; and

**Volume 2:** Class 1 & Class 10 Buildings - Housing Provisions.

Each volume presents regulatory Performance Requirements for different Building Solutions for various classes of buildings and performance provisions.

These Performance Provisions include: Structure; Fire Resistance; Damp & Weatherproofing; Sound Transmission & Insulation; and Energy Efficiency.

This design guide presents tables, charts and information necessary to design a Hebel PowerWall that complies with the Performance Requirements of the BCA. The designer must check the adequacy of the building solution for Performance Requirements outlined by the appropriate authority.





# 3.1 Hebel PowerFloor Installation Sequence



## 1. Preparation of Framing for Hebel PowerFloor Panel Installation

- Check floor framing is complete and within level tolerances.
- Provide set-out chalk lines, as required.
- Provide temporary installation platform where necessary.
- Ensure floor framing has adequate strength to support Hebel PowerFloor bundles.
- Position Hebel PowerFloor bundles on the floor framing.



## 2. Hebel PowerFloor Panel Installation

- Panels are to be installed in a stretcher bond pattern, with a minimum overlap of 1 joist space and not less than 450mm.
- Use lifting handles or trolley to move the panels to installation area.
- Apply a 5mm min. bead of Fuller Max Bond construction adhesive (or equivalent) to top of joists in accordance with manufacturer's instructions, and apply Hebel Adhesive to appropriate panel edges.
- Panels must be installed with minimal horizontal sliding on the joists to ensure a good bond. Force the tongue and groove joint closed as the panel is rolled and lowered onto the joists. Ensure all joints are tight and that adhesive makes full contact along all joints.
- Screw fix panel to the joists as required.
- Repeat process, removing excess Hebel Adhesive.



## 3. Penetration Detailing

- Install blocking to support Hebel PowerFloor panel at major openings.



## 4. Floor Finishes

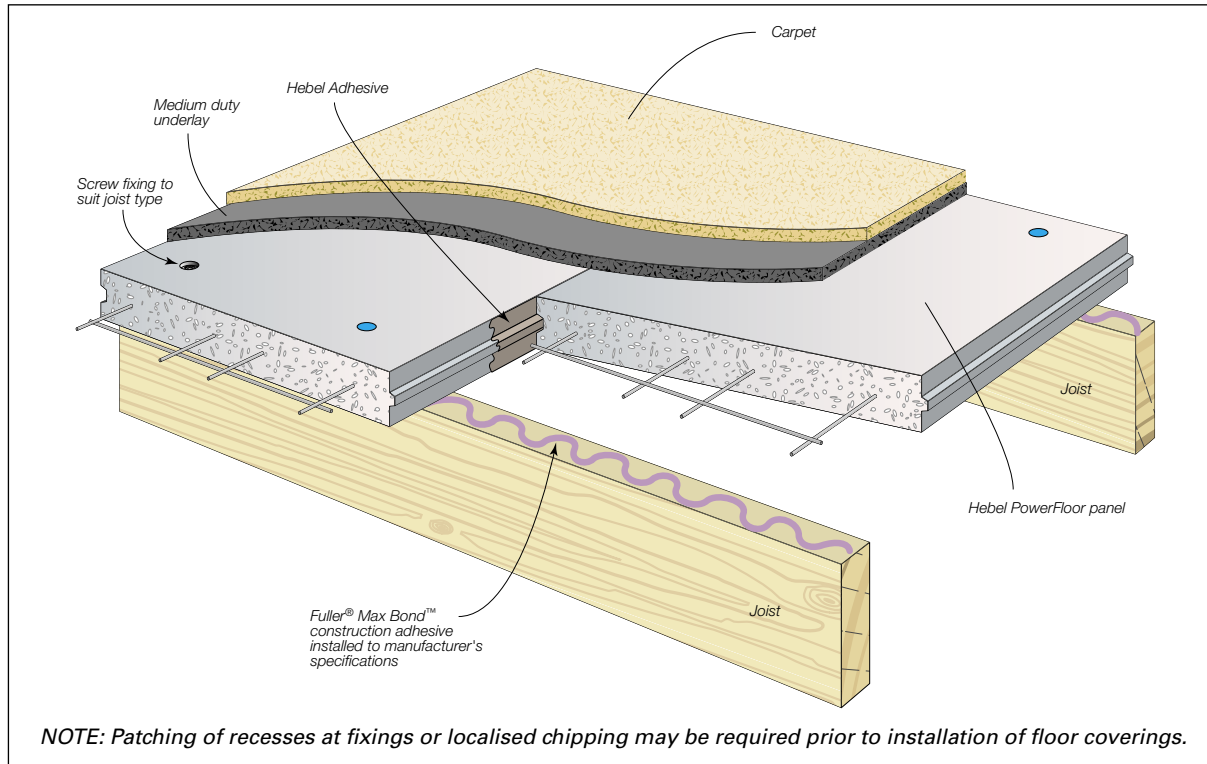
- Sweep the floor surface to remove debris and loose particles.
- Fill joints and screw holes with Hebel Adhesive, as required.
- Ensure perimeter is not chipped.
- Install floor covering for Hebel PowerFloor system in accordance with manufacturer's specifications.

*Note: Ensure panel moisture content is within limits outlined by the floor covering manufacturer.*

# 3.2 Construction Details

## Hebel PowerFloor System Carpet

Recommended for: Rigid, lightweight floor system with high impact sound insulation.

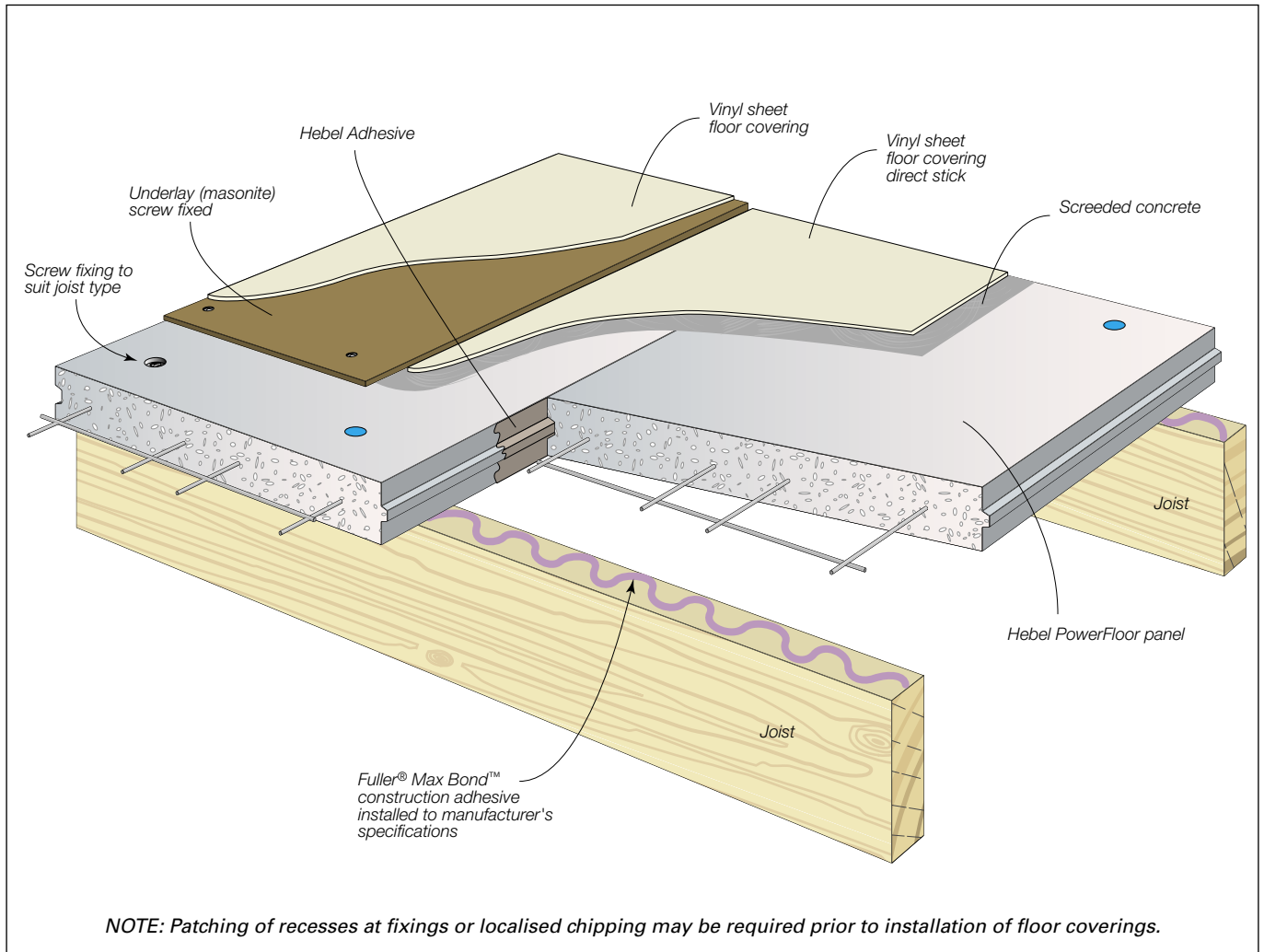


Carpet		Fire*	Acoustic			Thermal	
Code	System Description	FRL	R <sub>w</sub>	R <sub>w</sub> +C <sub>tr</sub>	L <sub>nw</sub> + C <sub>1</sub>	R-value up	R-value down
Hebel 1600	Hebel Res Floor Carpet Ground Floor Enclosed	240 minutes*	33	30	45	1.60	1.72
Hebel 1601	Hebel Res Floor Carpet Ground Floor Unenclosed	240 minutes*	33	30	45	1.01	1.06
Hebel 1602	Hebel Res Floor Carpet 2nd Storey Gyprock Ceiling (CSR 821)	-/-	55	48	35	2.68	3.01
Hebel 1603	Hebel Res Floor Carpet 2nd Storey Gyprock Ceiling (CSR 826)	60/60/60	56	49	34	3.17	3.55
Hebel 1604	Hebel Res Floor Carpet 2nd Storey Gyprock Ceiling (CSR 827)	90/90/90	58	52	32	2.77	3.11

Note \*Fire source from above only.  
Please refer to description on page 23 for all Acoustic, Thermal and Fire assessments.

# Hebel PowerFloor System Vinyl Sheet with Masonite

Recommended for: Rigid, lightweight floor system with good thermal insulation and vinyl floor covering.

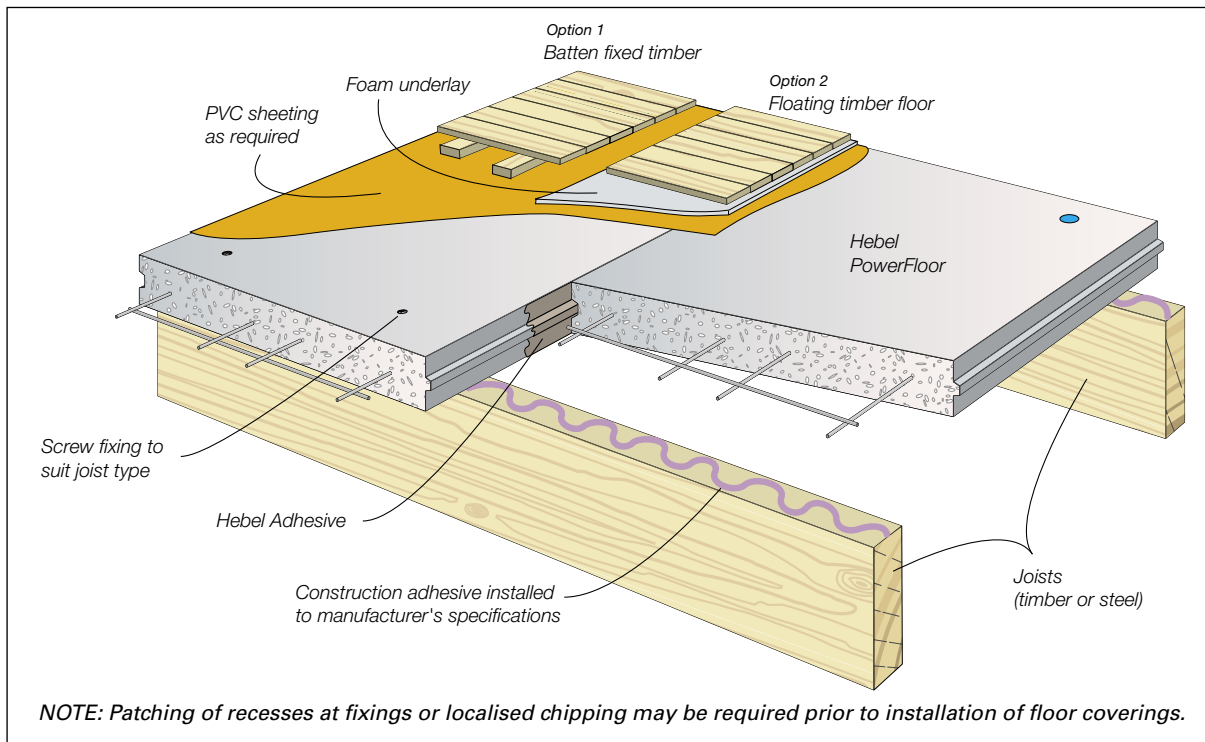


Vinyl Sheet with Masonite		Fire*	Acoustic			Thermal	
Code	System Description	FRL	R <sub>w</sub>	R <sub>w</sub> +C <sub>tr</sub>	L <sub>nw</sub> + C <sub>1</sub>	R-value up	R-value down
Hebel 1615	Hebel Res Floor Vinyl Ground Floor Enclosed	240 minutes*	37	33	76	1.38	1.45
Hebel 1616	Hebel Res Floor Vinyl Ground Floor Unenclosed	240 minutes*	37	33	76	0.74	0.79
Hebel 1617	Hebel Res Floor Vinyl 2nd Storey Gyprock Ceiling (CSR 821)	-/-	58	51	70	2.41	2.74
Hebel 1618	Hebel Res Floor Vinyl 2nd Storey Gyprock Ceiling (CSR 826)	60/60/60	58	51	69	2.91	3.28
Hebel 1619	Hebel Res Floor Vinyl 2nd Storey Gyprock Ceiling (CSR 827)	90/90/90	60	54	68	2.51	2.84

Note \*Fire source from above only  
Please refer to description on page 23 for all Acoustic, Thermal and Fire assessments.

## Hebel PowerFloor System Timber Floors

Recommended for: Rigid, lightweight floor system with excellent thermal insulation and decorative timber flooring.



Timber on Battens		Fire*	Acoustic			Thermal	
Code	System Description	FRL	R <sub>w</sub>	R <sub>w</sub> +C <sub>tr</sub>	L <sub>nw</sub> + C <sub>1</sub>	R-value up	R-value down
Hebel 1620	Hebel Res Floor Timber Battens Ground Floor Enclosed	240 minutes*	37	33	83	1.65	1.74
Hebel 1621	Hebel Res Floor Timber Battens Ground Floor Unenclosed	240 minutes*	37	33	83	1.00	1.08
Hebel 1622	Hebel Res Floor Timber Battens 2nd Storey Gyprock Ceiling (CSR 821)	-/-	55	48	66	2.66	3.03
Hebel 1623	Hebel Res Floor Timber Battens 2nd Storey Gyprock Ceiling (CSR 826)	60/60/60	56	48	66	3.17	3.57
Hebel 1624	Hebel Res Floor Timber Battens 2nd Storey Gyprock Ceiling (CSR 827)	90/90/90	58	50	63	2.75	3.13

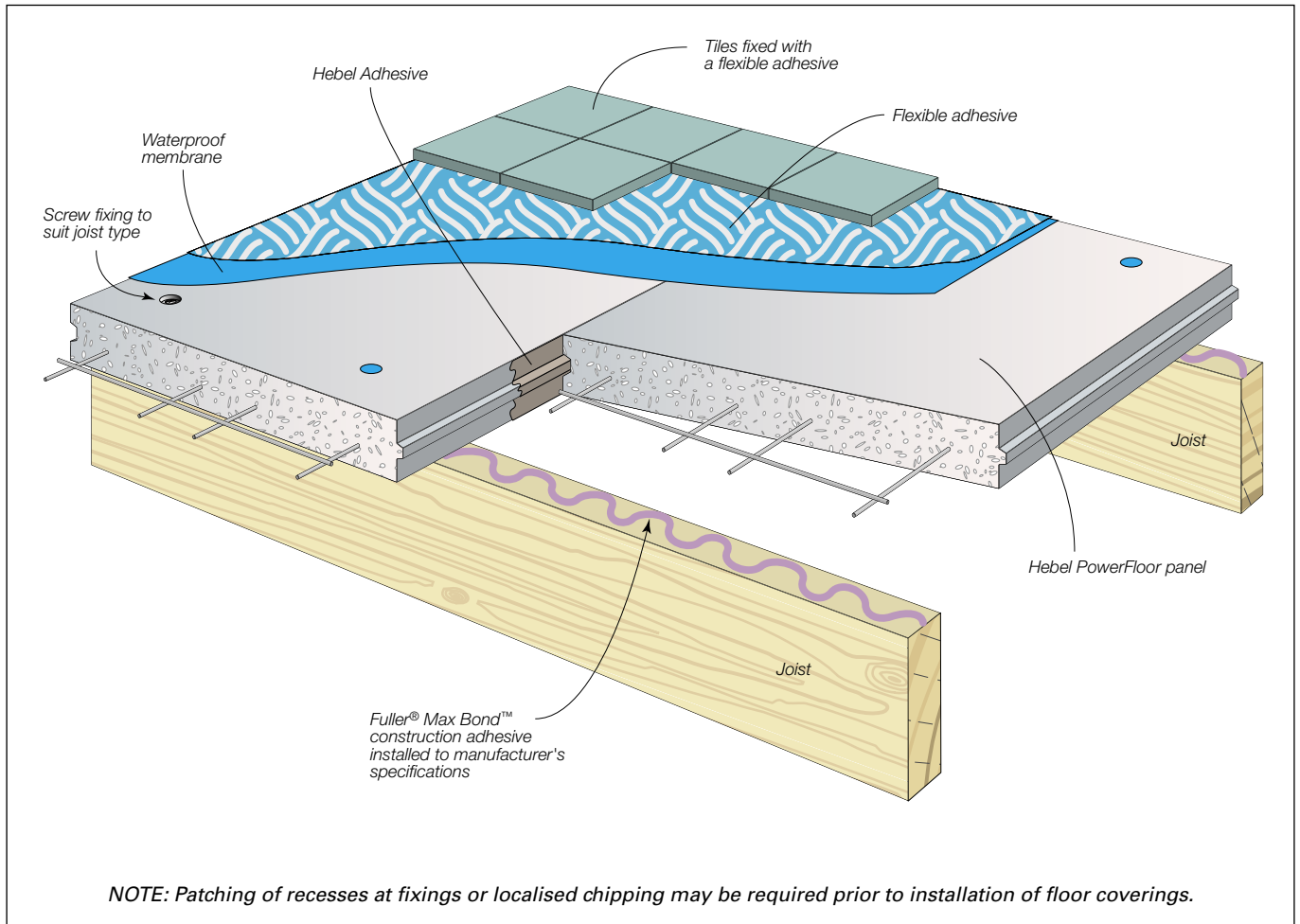
Timber Floating Floor		Fire*	Acoustic			Thermal	
Code	System Description	FRL	R <sub>w</sub>	R <sub>w</sub> +C <sub>tr</sub>	L <sub>nw</sub> + C <sub>1</sub>	R-value up	R-value down
Hebel 1625	Hebel Res Floor Timber Floating Ground Floor Enclosed	240 minutes*	37	33	83	1.52	1.59
Hebel 1626	Hebel Res Floor Timber Floating Ground Floor Unenclosed	240 minutes*	37	33	83	0.88	0.93
Hebel 1627	Hebel Res Floor Timber Floating 2nd Storey Gyprock Ceiling (CSR 821)	-/-	55	48	66	2.55	2.88
Hebel 1628	Hebel Res Floor Timber Floating 2nd Storey Gyprock Ceiling (CSR 826)	60/60/60	56	48	60-70	3.04	3.42
Hebel 1629	Hebel Res Floor Timber Floating 2nd Storey Gyprock Ceiling (CSR 827)	90/90/90	58	51	69	2.64	2.98

Note \*Fire source from above only

Please refer to description on page 23 for all Acoustic, Thermal and Fire assessments.

# Hebel PowerFloor System 8mm Ceramic Tiles

Recommended for: Rigid, lightweight floor system for wet areas while maintaining a high level of thermal insulation.

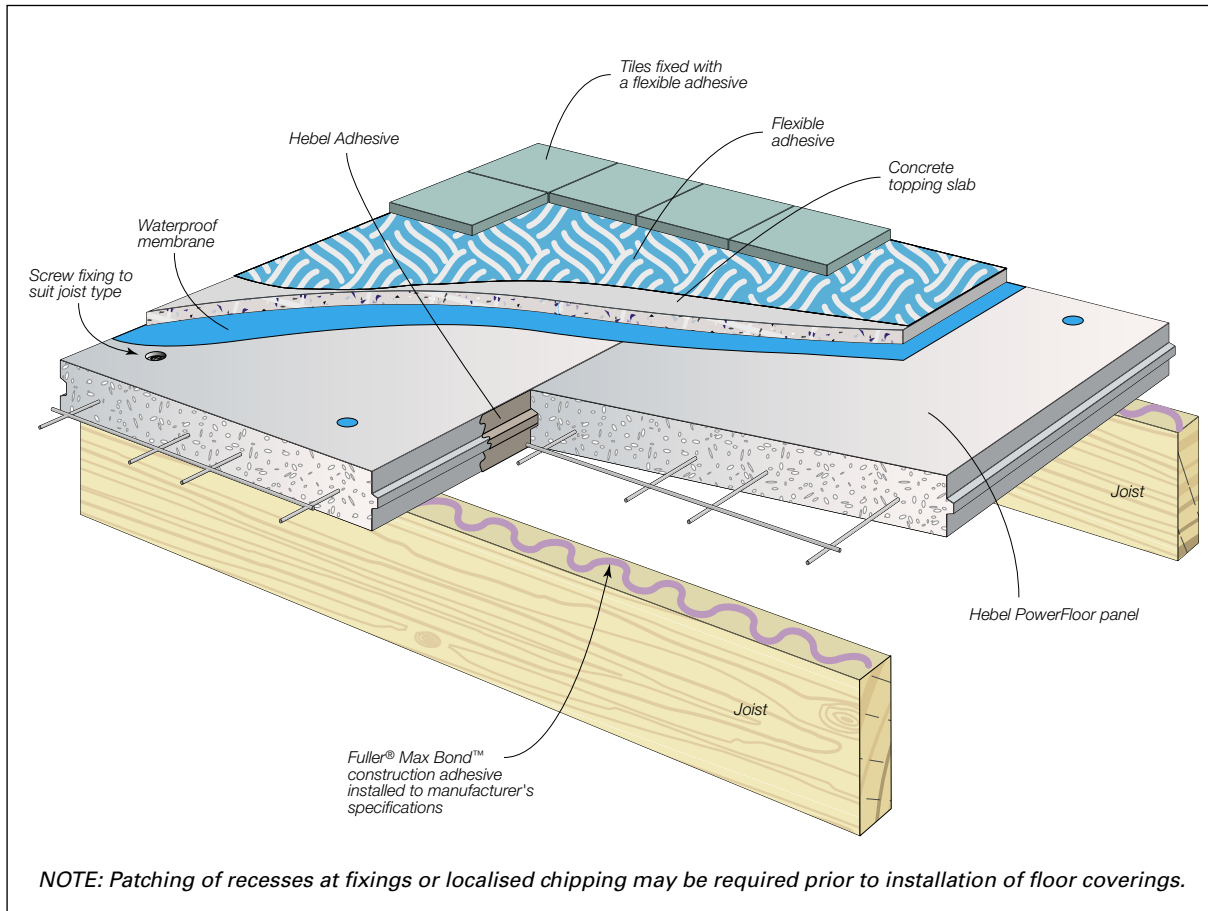


8mm Ceramic Tiles		Fire*	Acoustic			Thermal	
Code	System Description	FRL	R <sub>w</sub>	R <sub>w</sub> +C <sub>tr</sub>	L <sub>nw</sub> + C <sub>1</sub>	R-value up	R-value down
Hebel 1605	Hebel Res Floor Tiles Ground Floor Enclosed	240 minutes*	36	31	72	1.33	1.45
Hebel 1606	Hebel Res Floor Tiles Ground Floor Unenclosed	240 minutes*	36	31	72	0.74	0.79
Hebel 1607	Hebel Res Floor Tiles 2nd Storey Gyprock Ceiling (CSR 821)	-/-	54	48	64	2.41	2.74
Hebel 1608	Hebel Res Floor Tiles 2nd Storey Gyprock Ceiling (CSR 826)	60/60/60	56	50	62	2.90	3.28
Hebel 1609	Hebel Res Floor Tiles 2nd Storey Gyprock Ceiling (CSR 827)	90/90/90	58	52	60	2.51	2.84

Note \*Fire source from above only  
Please refer to description on page 23 for all Acoustic, Thermal and Fire assessments.

## Hebel PowerFloor System 8mm Ceramic Tiles on 50mm Topping Slab

Recommended for: Rigid, lightweight floor system where a fall is required for drainage.



8mm Ceramic Tiles on 50mm Topping Slab		Fire*	Acoustic			Thermal	
Code	System Description	FRL	R <sub>w</sub>	R <sub>w</sub> +C <sub>tr</sub>	L <sub>nw</sub> + C <sub>1</sub>	R-value up	R-value down
Hebel 1610	Hebel Res Floor Tiles on Topping Slab Ground Floor Enclosed	240 minutes*	37	33	72	1.42	1.49
Hebel 1611	Hebel Res Floor Tiles on Topping Slab Ground Floor Unenclosed	240 minutes*	37	33	72	0.77	0.82
Hebel 1612	Hebel Res Floor Tiles on Topping Slab 2nd Storey Gyprock Ceiling (CSR 821)	-/-	56	49	57	2.45	2.78
Hebel 1613	Hebel Res Floor Tiles on Topping Slab 2nd Storey Gyprock Ceiling (CSR 826)	60/60/60	57	50	56	2.94	3.31
Hebel 1614	Hebel Res Floor Tiles on Topping Slab 2nd Storey Gyprock Ceiling (CSR 827)	90/90/90	59	53	54	2.54	2.87

Note \*Fire source from above only

### Description

Fire from above only - Opinion FCO 1303

Fire from below only - Opinion FCO 1373. (Refer to CSR Gyprock)

Combined floor and ceiling system thermal values are opinions determined for internal conditions above and internal conditions below. Airflow direction - Up = Summer, Down = Winter

Acoustic Test CSIRO - TL413 - airborne sound transmission

Acoustic Test CSIRO - TLi413 - impact sound transmission

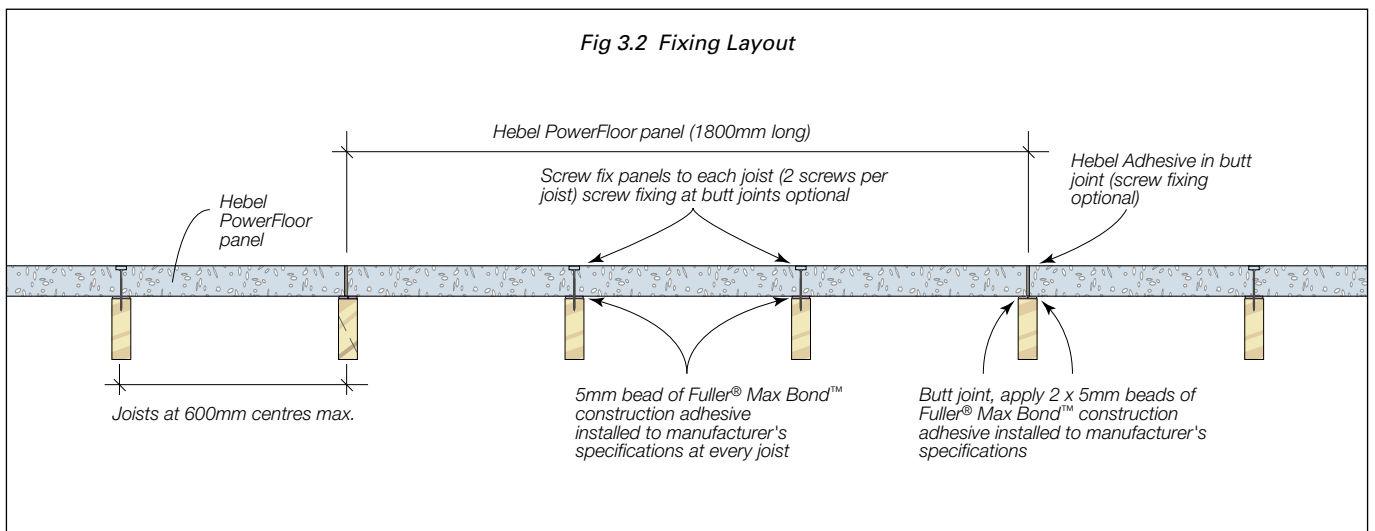
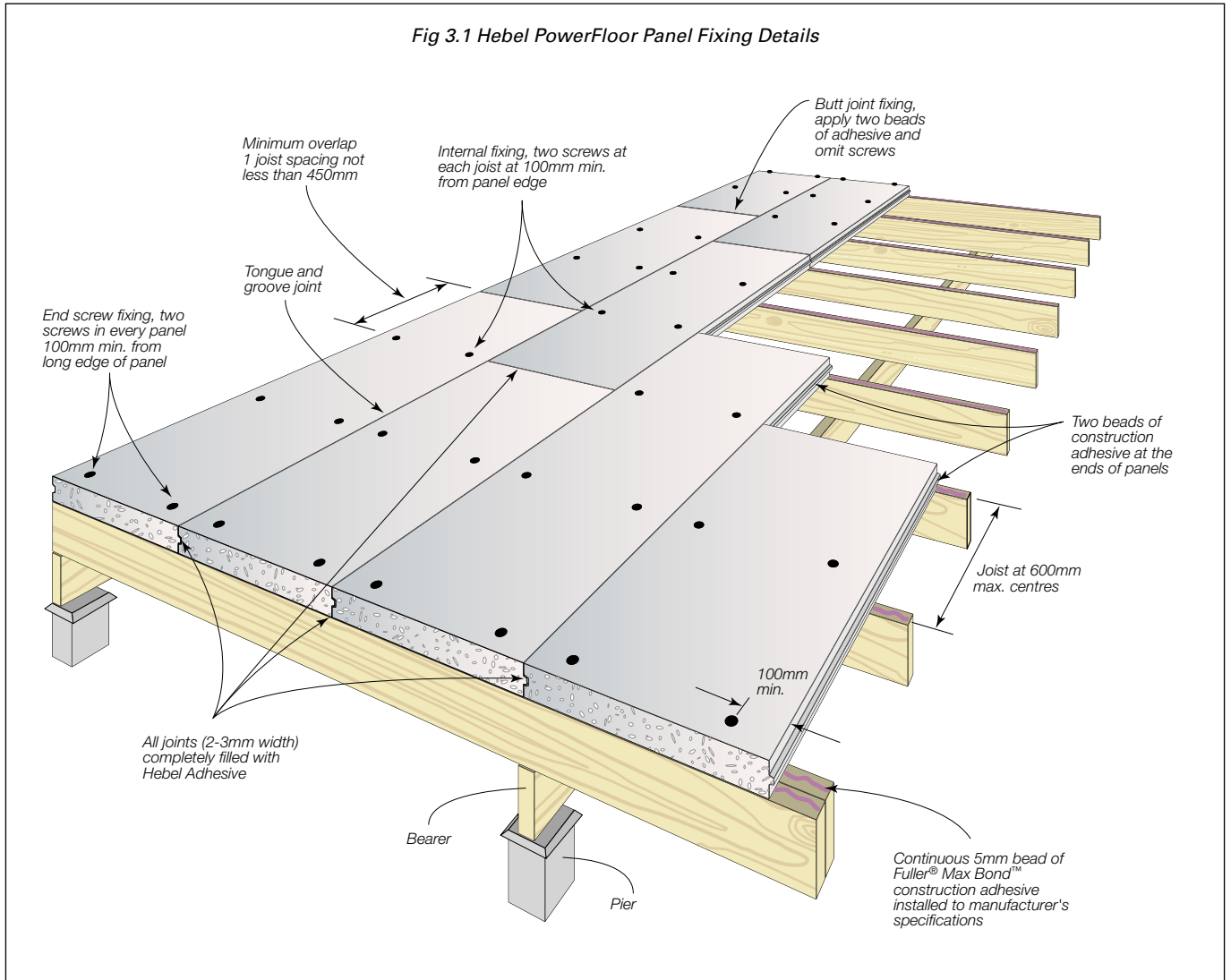
Acoustic Assessment PKA - 210 091 A071

Thermal calculation by James Fricker 107.23 to 107.29 June 2010

Note: Thermal values for CSR 827 ceiling options are taken to be the values for CSR 829 in the report. This is slightly conservative as CSR 827 has 2 x 16mm Fyrchek instead of 1 x 13mm Fyrchek + 1 x 16mm Fyrchek, everything else is the same. The difference is about R0.017.

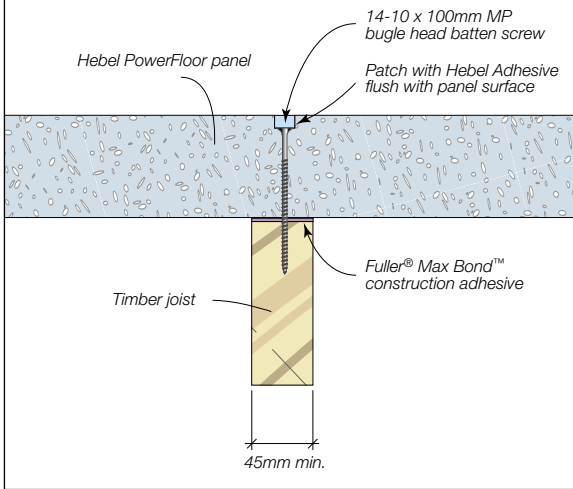
For detailed information on ceiling systems, please refer to 'System Components' Section of this design guide and the CSR Gyprock Fibre Cement Fire & Acoustic Design Guide (The Red Book™). For detailed information on acoustic testing, please contact CSR Hebel.

# 3.3 Hebel PowerFloor Panel Fixing Details

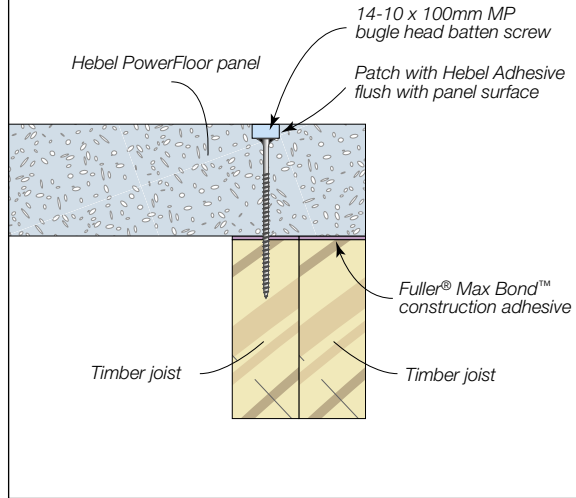




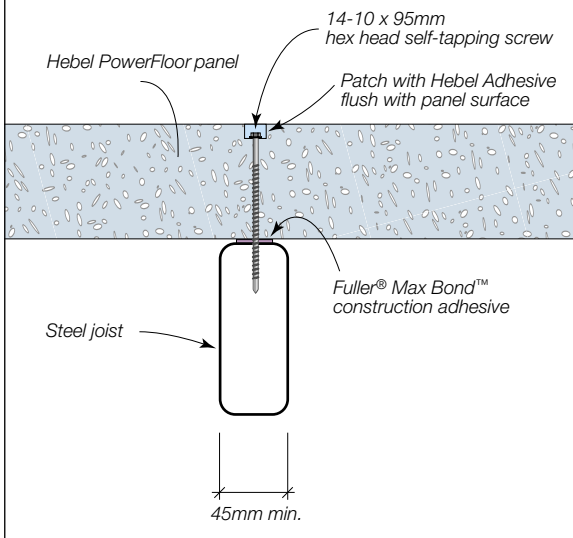
**Fig 3.3 Fixing of Hebel PowerFloor Panel to Timber Joists**



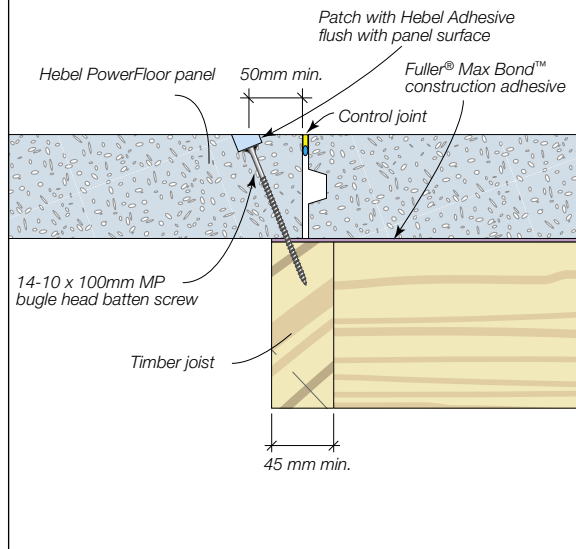
**Fig 3.4 Fixing at End of Hebel PowerFloor Panel to Timber Joists**



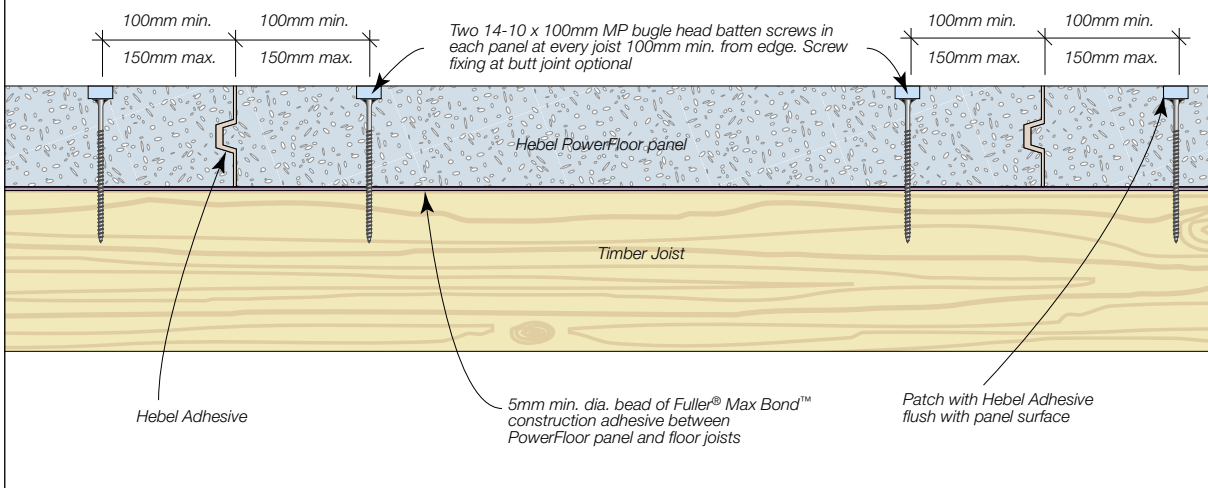
**Fig 3.5 Fixing of Hebel PowerFloor Panel to Steel Joists**



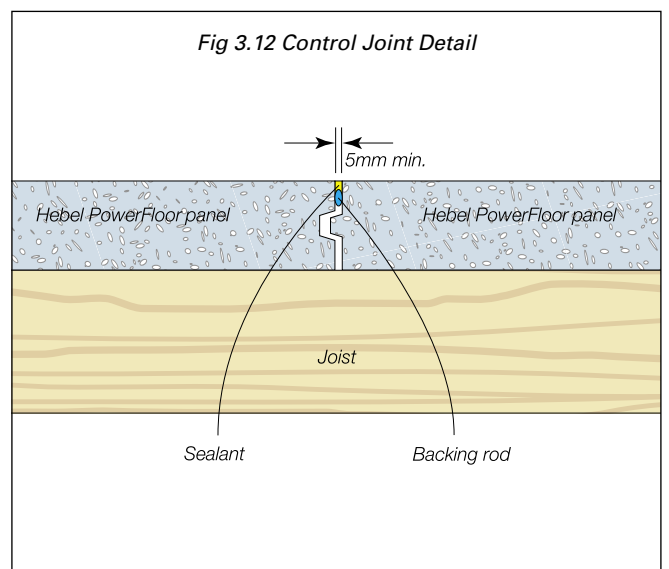
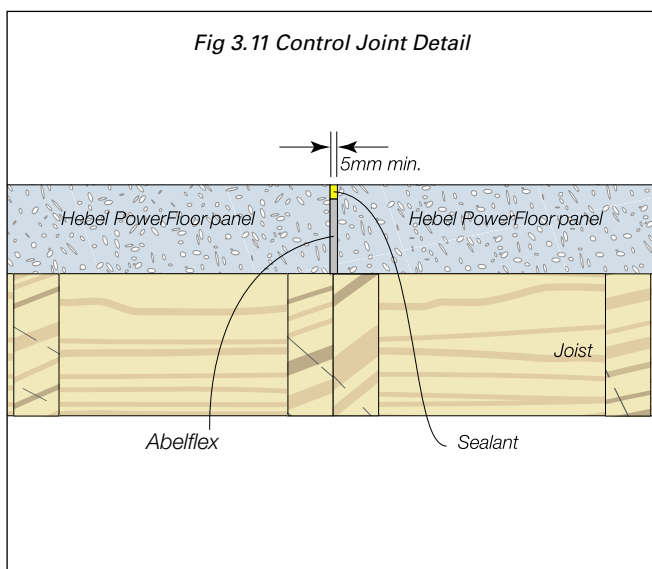
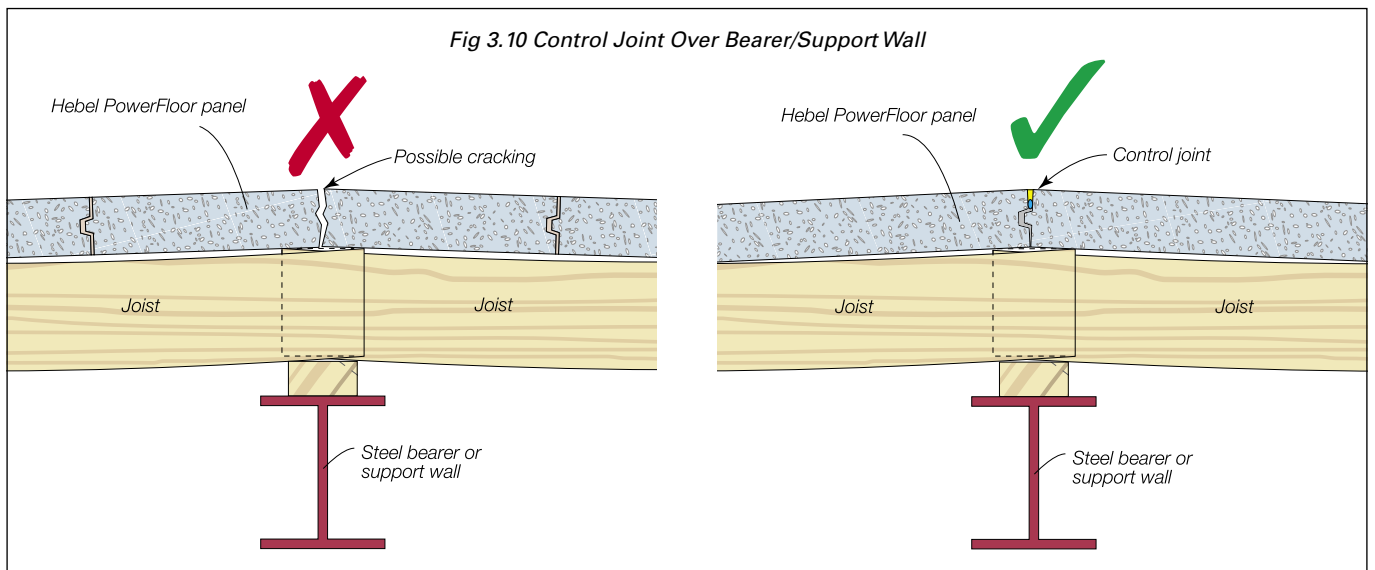
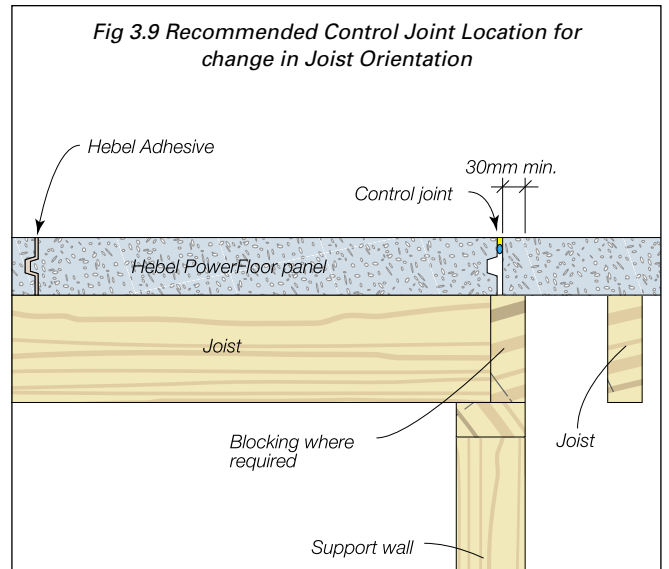
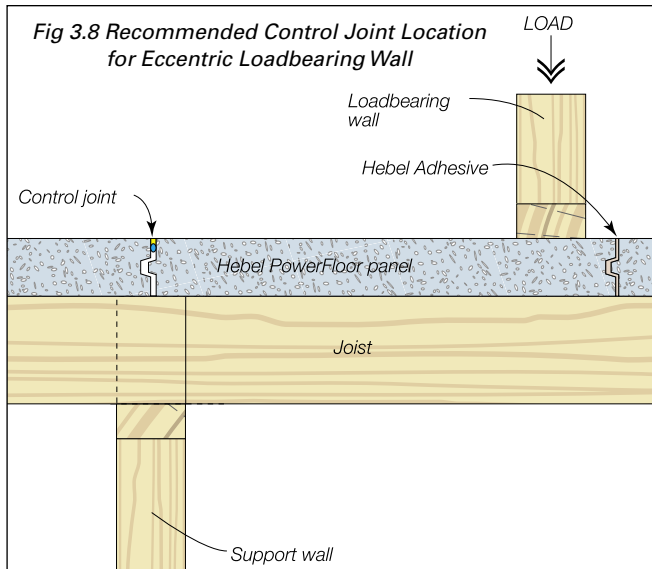
**Fig 3.6 Fixing to Timber Joists at change in Joist Orientation**



**Fig 3.7 Cross-section of Hebel PowerFloor Panel Installation**



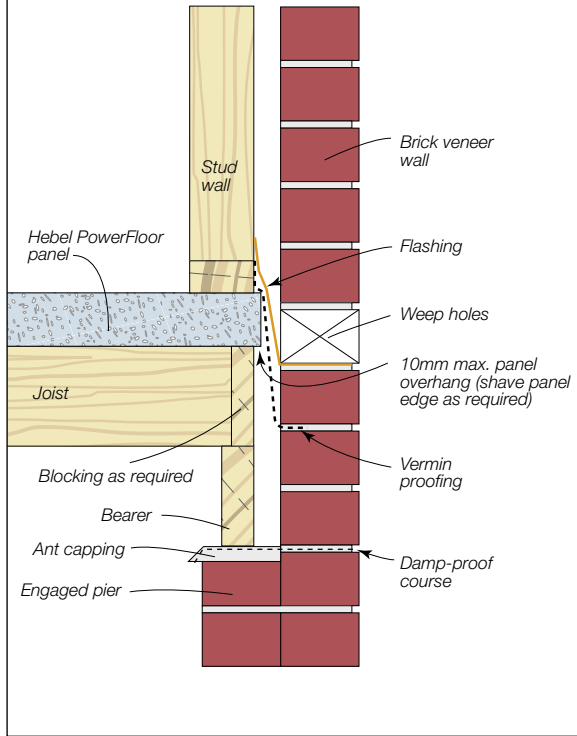
# 3.4 Control Joint Details



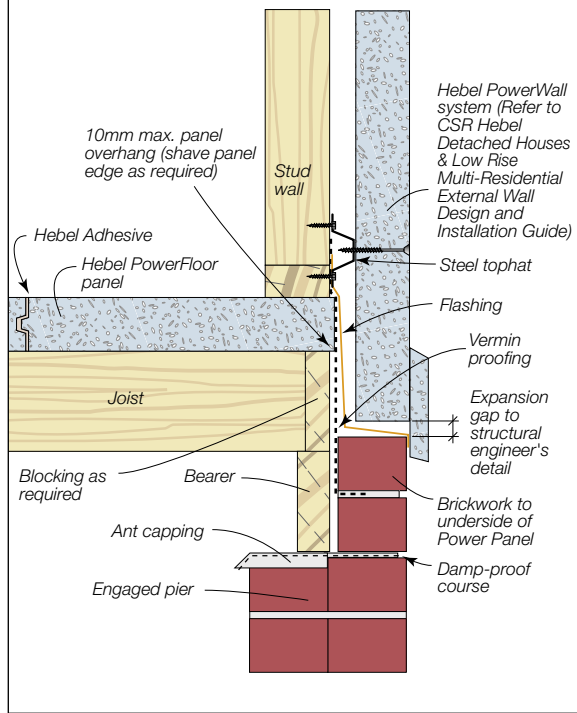
# 3.5 Construction Details

**NOTE:** The detailing of the cladding system shown below is for indicative purposes only. The project designer shall specify the construction details for the project.

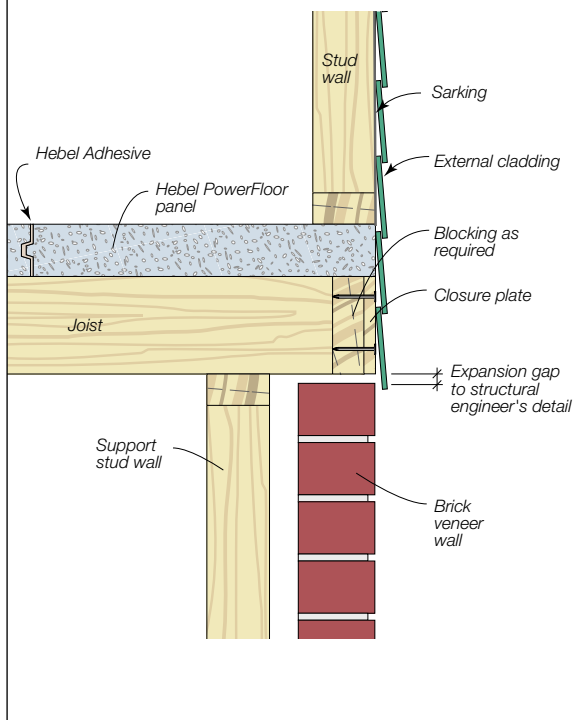
**Fig 3.13 Edge Blocking Detail Between Joists**



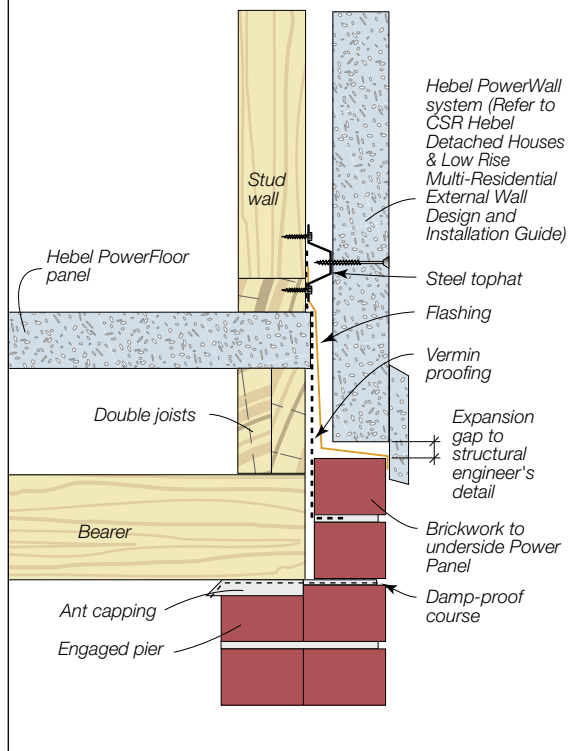
**Fig 3.14 Edge Blocking Detail Between joints, with Hebel PowerFloor and Hebel Low Rise External Wall System**



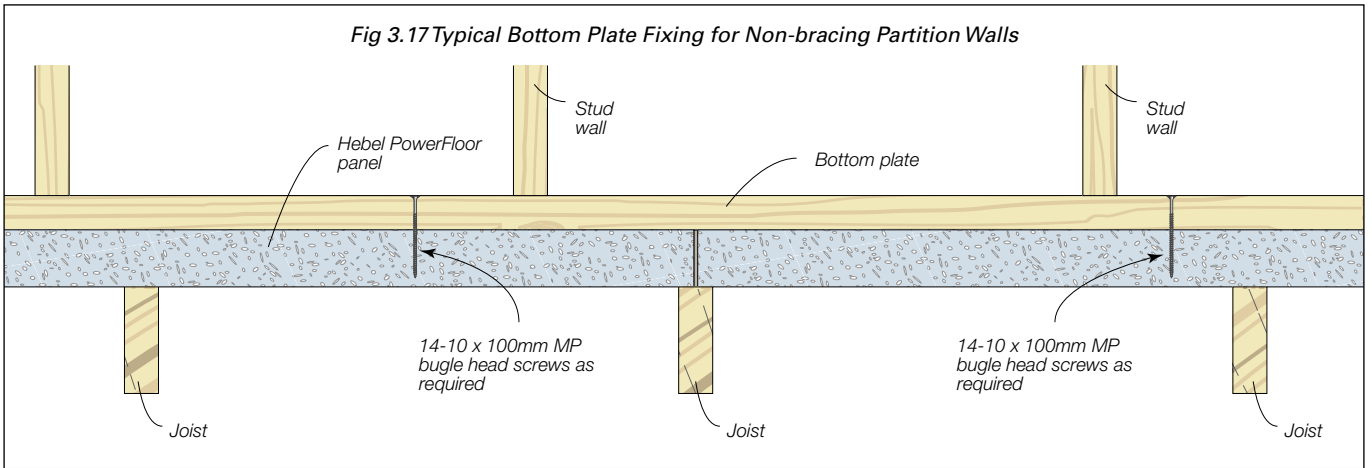
**Fig 3.15 Constructed Detail at Cantilevered Joist**



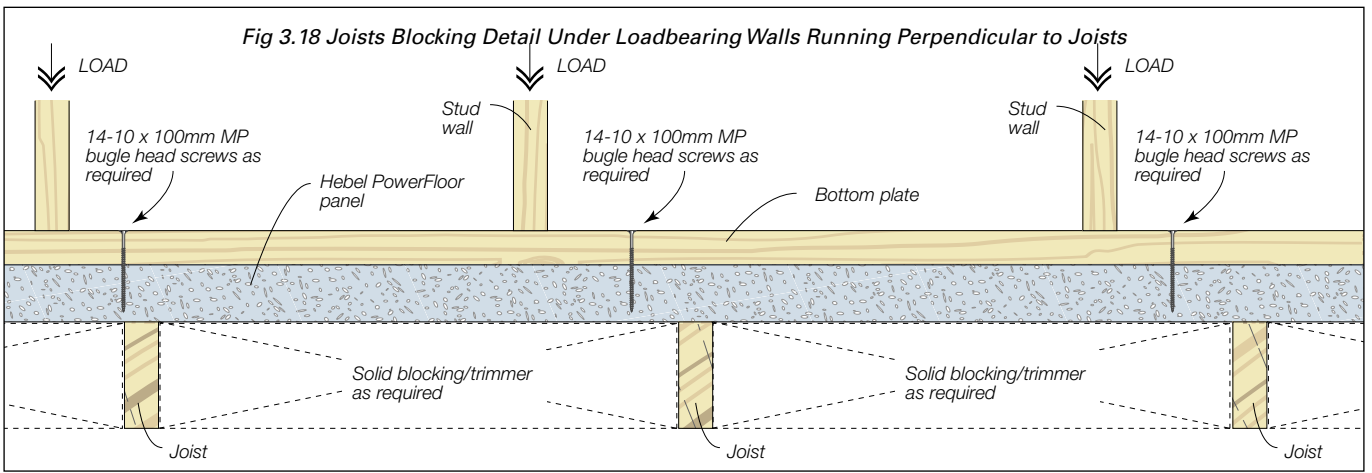
**Fig 3.16 Hebel PowerFloor End Support Detail**



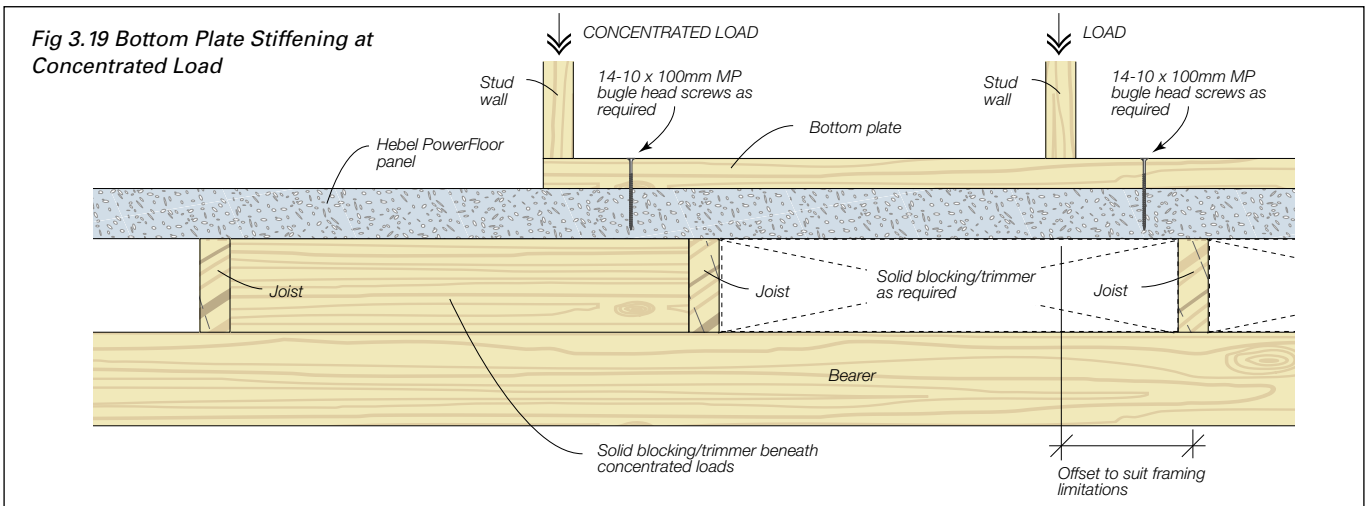
**Fig 3.17 Typical Bottom Plate Fixing for Non-bracing Partition Walls**



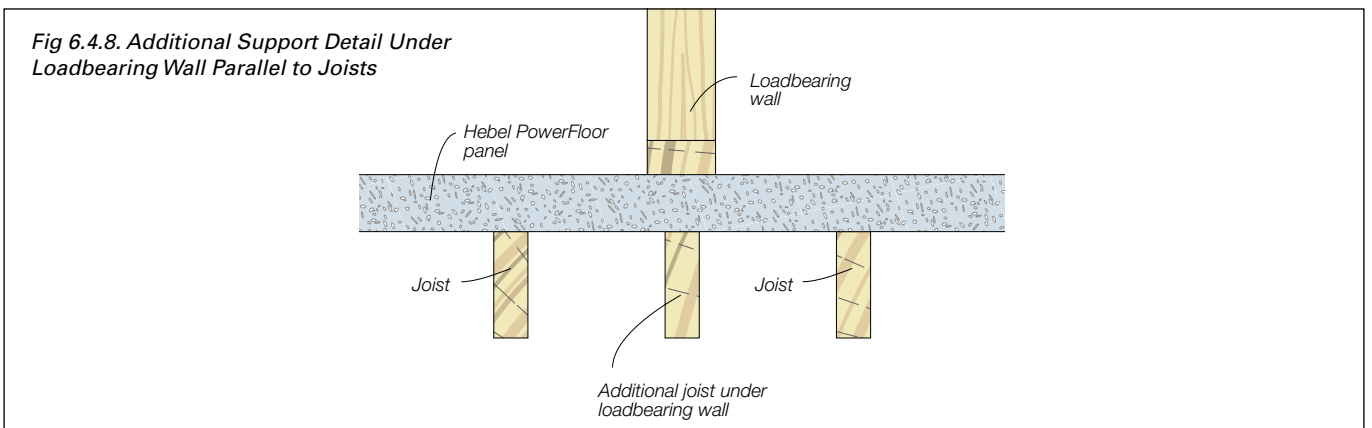
**Fig 3.18 Joists Blocking Detail Under Loadbearing Walls Running Perpendicular to Joists**



**Fig 3.19 Bottom Plate Stiffening at Concentrated Load**

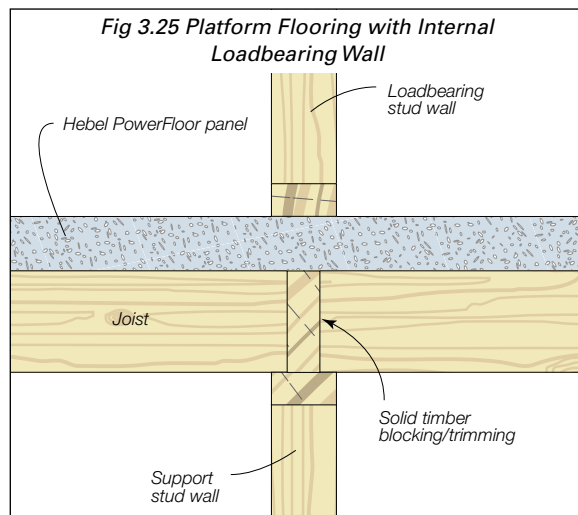
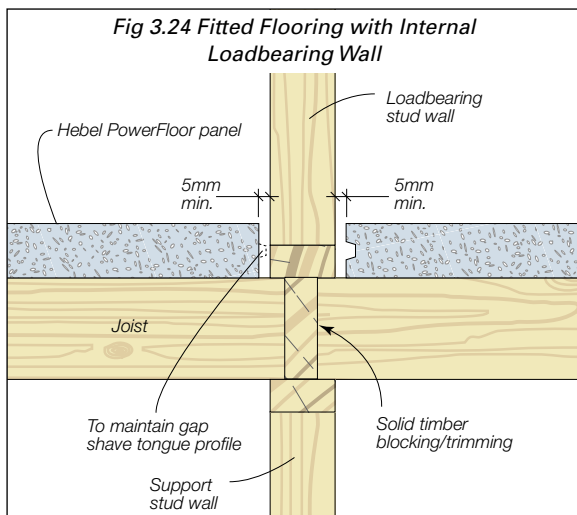
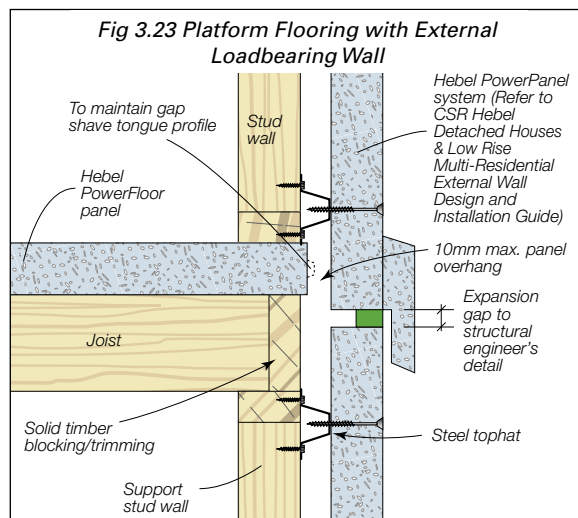
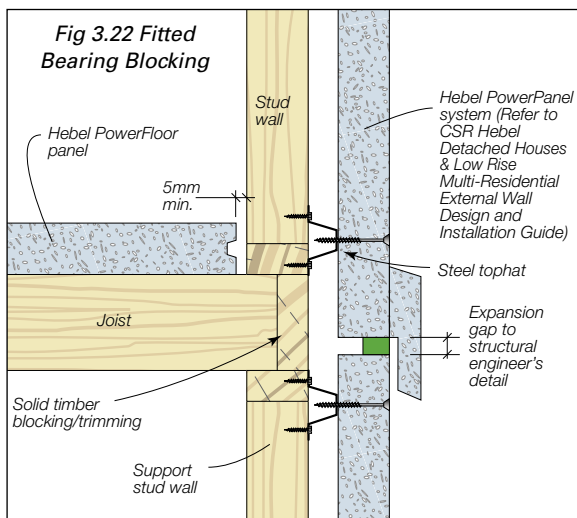
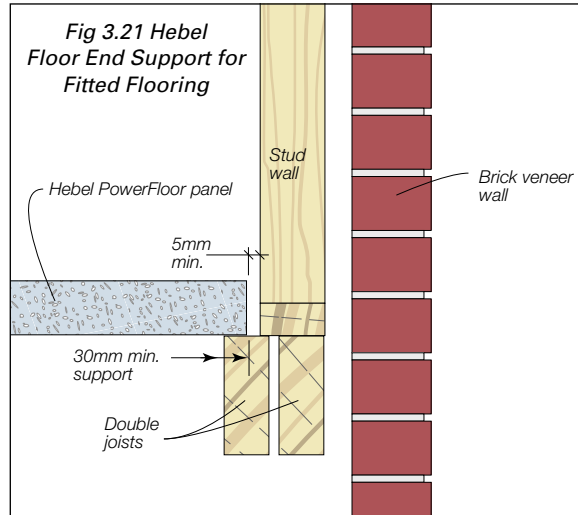
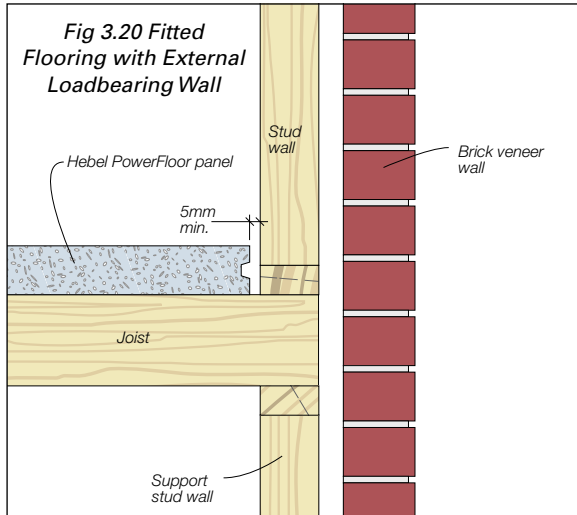


**Fig 6.4.8. Additional Support Detail Under Loadbearing Wall Parallel to Joists**



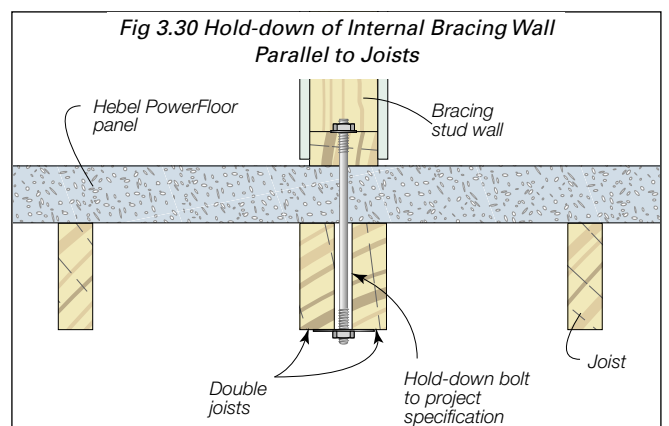
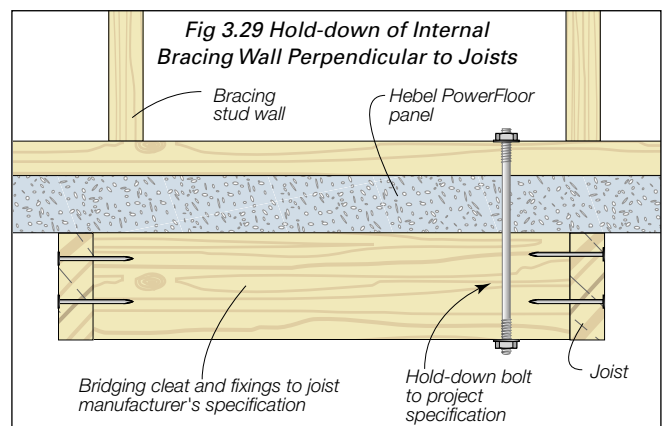
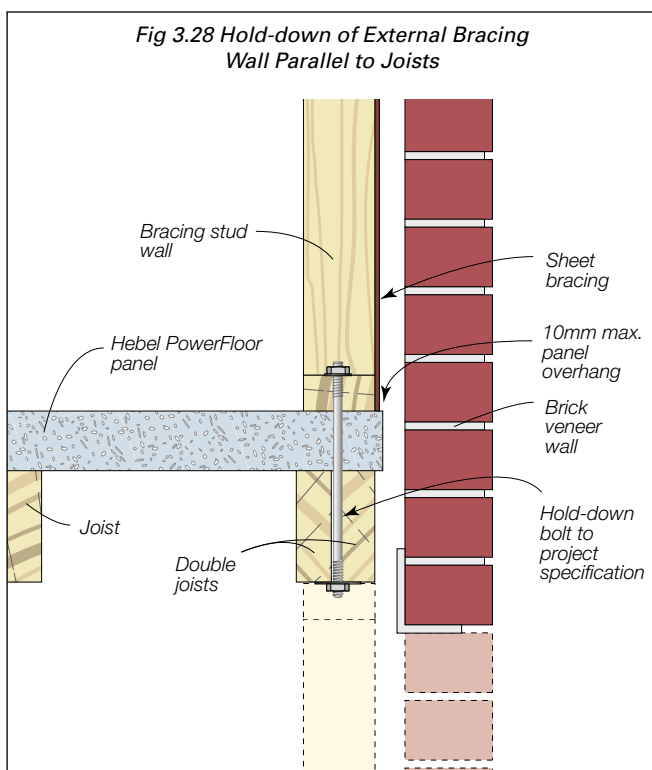
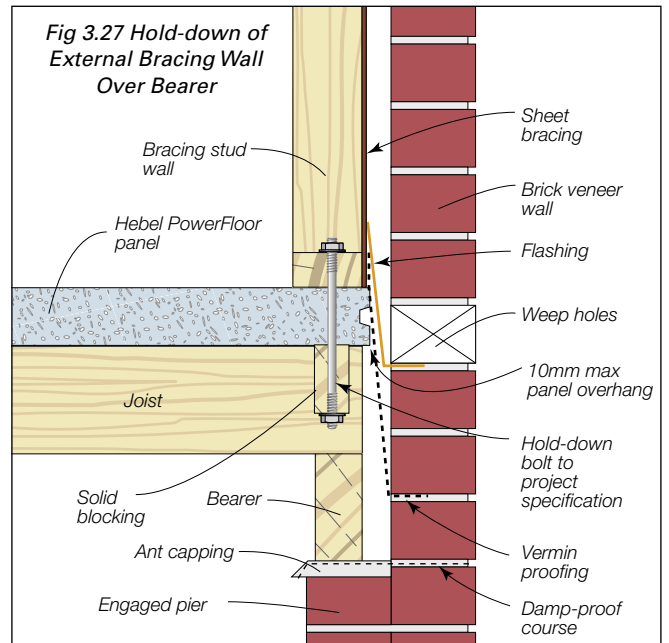
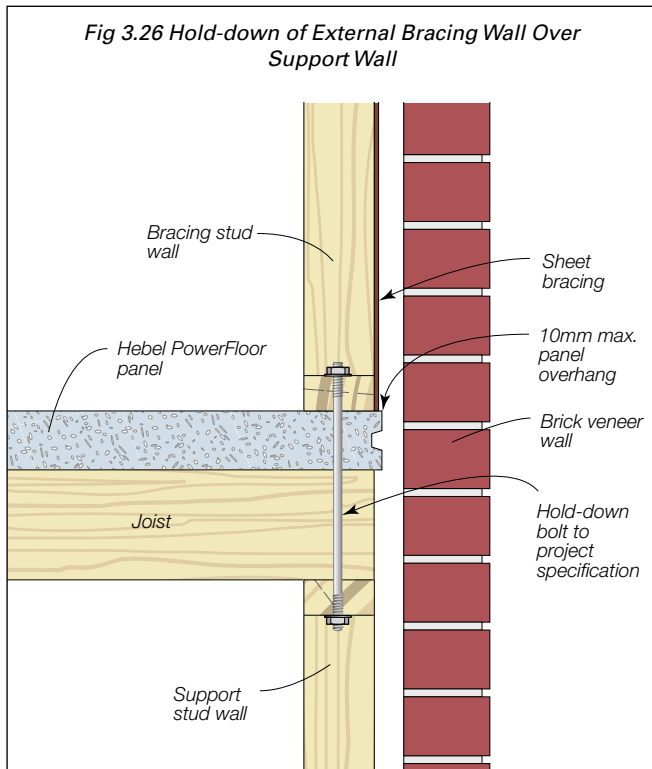
# 3.6 Multi-Level Construction Details

**NOTE:** • Fitted flooring is required where the bearing stress in the Hebel PowerFloor panel, at the top of joists or the top of blocking between joists exceeds 1MPa.  
 • The detailing of the cladding system shown below is for indicative purposes only.  
 The project designer shall specify the construction details for the project.

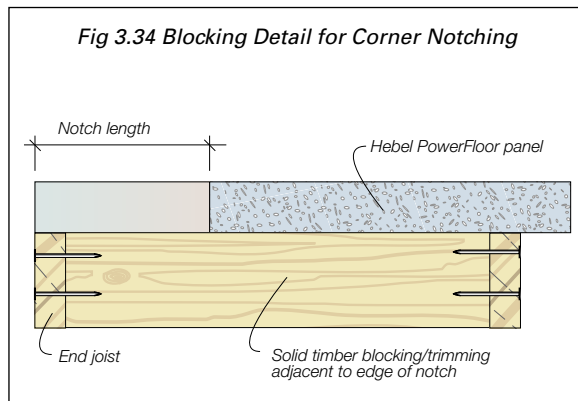
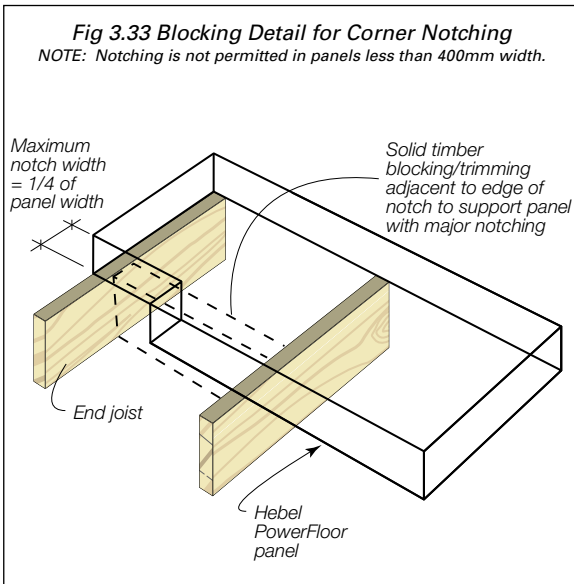
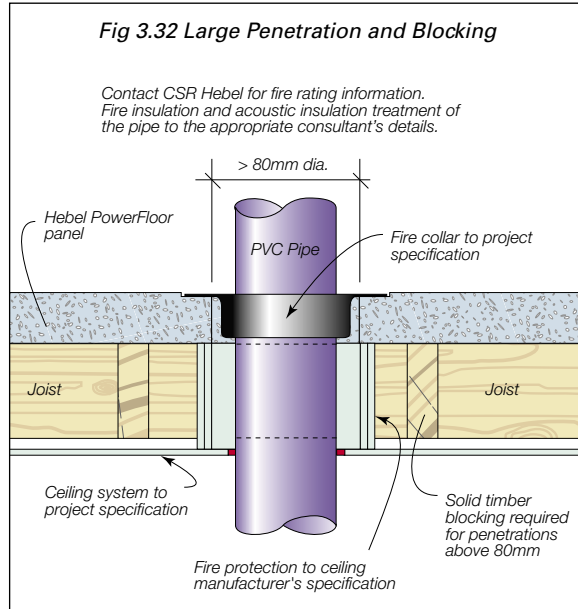
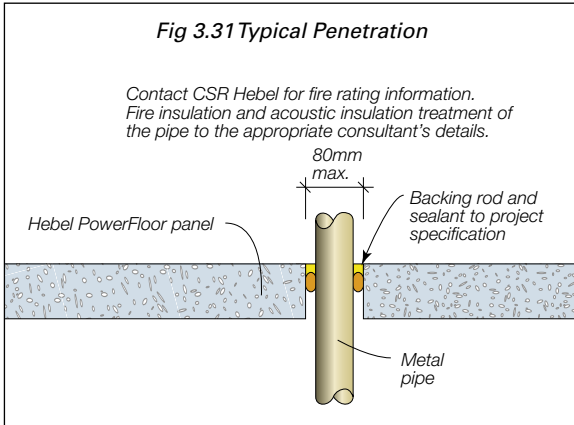


# 3.7 Hold-Down/Bracing Wall Details

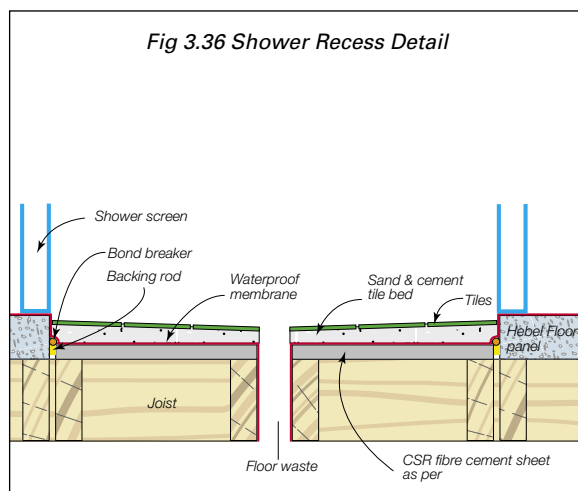
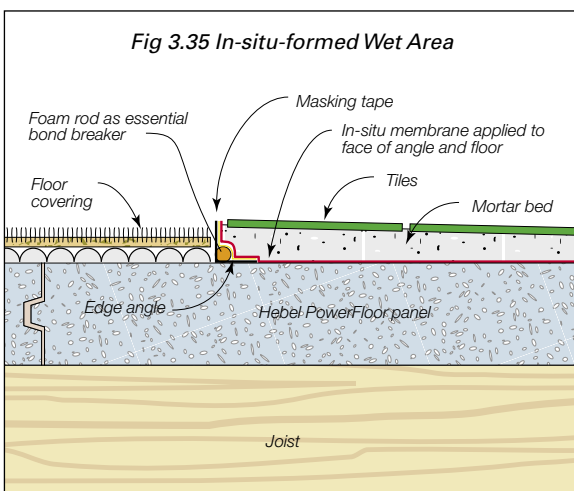
**NOTE:** • For hold-down connections other than bolts, ensure the minimum requirements for embedment into timber is maintained. Refer to AS1684.2 for hold-down connection requirements.  
 • The detailing of the cladding system shown below is for indicative purposes only. The project designer shall specify the construction details for the project.



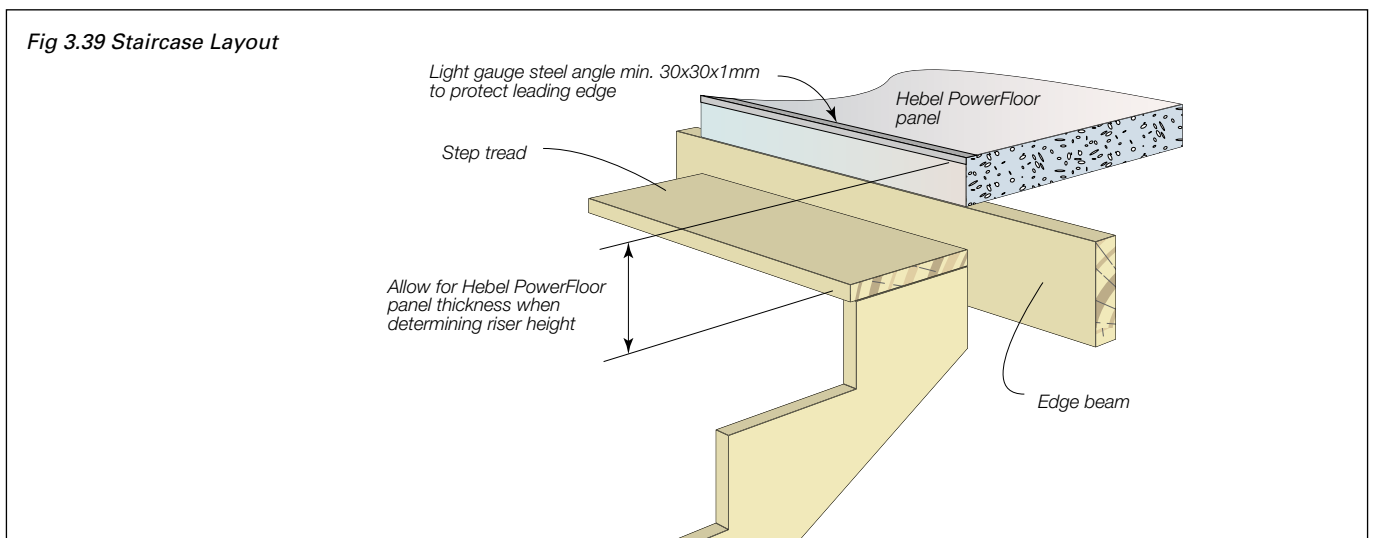
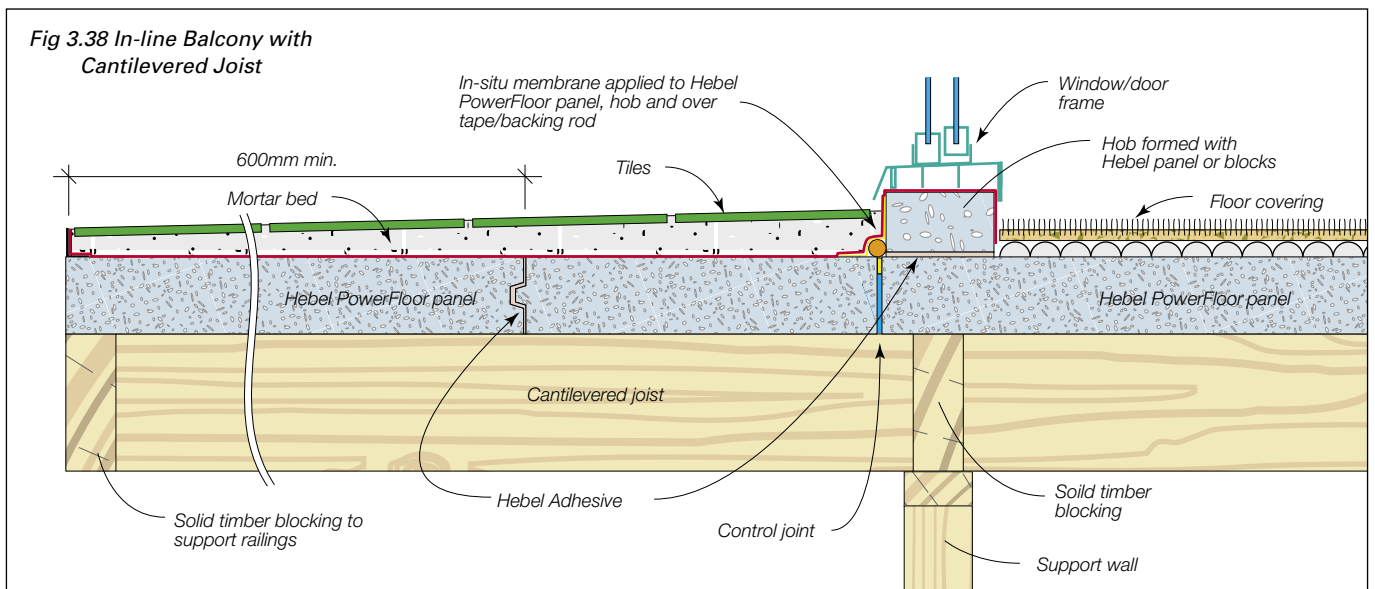
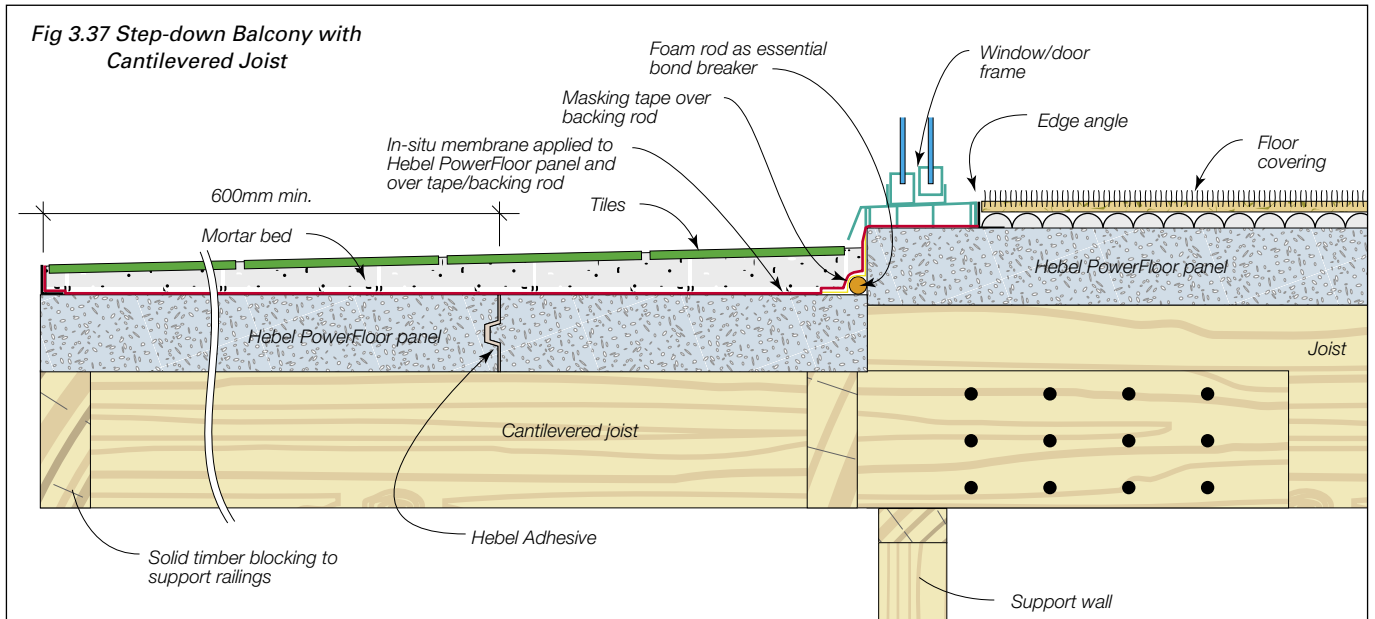
# 3.8 Penetrations and Notching Details



# 3.9 Wet Area Detail



# 3.10 Balcony and Staircase Details





# 3.11 Floor Covering Installation

The following sections describe the type of preparation required and any special considerations for common floor coverings.

## Carpet Installation

### Panel Surface Preparation

Sweep the floor surface to remove debris and loose particles. Expose all surface blemishes such as chips, cracks, gaps, ridges or the like. Fill all unacceptable locations with an appropriate and compatible patching compound such as Hebel Patch or levelling compound as required. Ensure panels are then dry.



### Carpet Smooth Edge Installation

Installation of Carpet Smooth Edge (Gripper) is to be in accordance with AS/NZS 2455.1:1995.

Installation of carpet gripper prior to laying carpet requires the use of specifically selected nails or course threaded screws. Standard fixings supplied with the carpet gripper are not suitable for fixing to Hebel PowerFloor panels. Carpet gripper strips are available without factory supplied nails. For carpet gripper installation near the panel edge, only glue is recommended. If relying on glue only, the

carpet can not be stretched until the glue is set after approximately 24 hours.

### Underlay Installation

Minimum medium duty underlay is to be used. No other special requirements.

### Carpet Installation

As per carpet manufacturer's guidelines. No other special requirements.

Fig 3.40



Fig 3.41



Fixing Type	Description	Application Method	Installation Notes
Twist Nails	51mm dome head twist nail	Coil Nail Gun (Refer to Fig 7.1)	The head of the twist nail should finish flush with the surface of the gripper strip
Screws	Type 17 point - course thread No. 8g x 50mm - Countersinking screw	Makita 6834 Auto Feed Screwdriver (Refer to Fig 7.2)	The head of the twist nail should finish flush with the surface of the carpet gripper strip

# 3.12 Tile Installation

## Panel Surface Preparation

Sweep the floor surface to remove debris and loose particles. Expose all surface blemishes such as chips, cracks, gaps, ridges or the like. Fill all unacceptable locations with an appropriate and compatible patching compound such as Hebel Patch or levelling compound as required. Ensure panels are then dry.

## Tile Installation

As per manufacturer's guidelines. Apply tiles to screed or adhesive as per normal floor.

**Notes:** **Control Joints** - ensure Control Joints are installed in tiles at the appropriate location of floor Control Joints.  
**Penetration** - seal penetrations through waterproof membrane.

Case 1 Direct Stick Adhesive	Case 2 On Screed
<ul style="list-style-type: none"> <li>• Sealer as per manufacturer's recommendations</li> <li>• Waterproof membrane as required, for balconies and wet areas</li> </ul>	<ul style="list-style-type: none"> <li>• Sealer as per manufacturer's recommendations</li> </ul>



# 3.13 Vinyl Installation

## Panel Surface Preparation

Sweep the floor surface to remove debris and loose particles. Expose all surface blemishes such as chips, cracks, gaps, ridges or the like. Fill all unacceptable locations with an appropriate and compatible patching compound such as Hebel Patch or levelling compound as required. Ensure panels are then dry.

**Notes:**

1. Ensure panel preparation is completed properly and thoroughly to avoid crunching.
2. When screed is used, ensure that the additional load is taken into account in the sub floor design.

Components	Case 1 - Screed	Case 2 - Masonite
Concrete screed	As per tiles	Not required
Masonite	Not required	Install with twist nails as with carpet smooth edge
Vinyl	As per standard practice (no special requirements)	As per standard practice (no special requirements)

## 3.14 Timber Installation

### Panel Surface Preparation

Sweep the floor surface to remove debris and loose particles. Expose all surface blemishes such as chips, cracks, gaps, ridges or the like. Fill all unacceptable locations with an appropriate and compatible patching compound such as Hebel Patch or levelling compound as required. Ensure panels are then dry.

### Moisture

Timber is affected by changes in environmental conditions and it is good practice to allow the flooring to acclimatise to the environment before installation. If there is significant moisture in the Hebel PowerFloor (>6%) a membrane, such as min. 200 micron polyethylene sheeting, should be placed over the top surface of the Hebel PowerFloor.

### Timber Strip Flooring

Batten fix - ensuring flatness is not as critical as direct mechanical fix. Anchor battens at the required centres using anchors suitable for AAC, eg. Mungo MBSP1080.

Direct mechanical fix - install min. 12mm plywood sheets to Hebel PowerFloor using construction Maxbond or equivalent and 65-75mm coarse thread countersunk screws at max 600mm centres.

### Floating Timber Floor

Underlay / backing installed as per normal for a concrete slab.

No special requirements for floating timber flooring installation.

Fig 3.42 Timber Floor Covering



# 4.1 Delivery and storage

## Unloading Panel Packs

Panel packs shall be unloaded and moved with only approved lifting devices. Before use, the lifting devices should be checked for the required lifting tags. Packs should be unloaded as close as possible to the intended installation area. This will increase work efficiency and minimise the need for secondary lifting.

**NOTE:** *Secondary handling increases the risk of panel damage. The repair of damage sustained during lifting and moving is the responsibility of the lifter. Where damage is excessive, PowerClad panels must be replaced.*

## Storage

All materials must be kept dry and preferably stored undercover. Care should be taken to avoid sagging or damage to ends, edges and surfaces.

All Hebel products must be stacked on edge and properly supported off the ground, on a level platform. Panel bundles can be stacked two high. The project engineer should be consulted as to the adequacy of the structure to support the stacked bundles.

If outside, Hebel panels must be stored off the ground and protected from the weather. Only single bundles positioned on the ground can be opened. To provide a level surface, we recommend placing temporary joists beneath the supporting cleats.

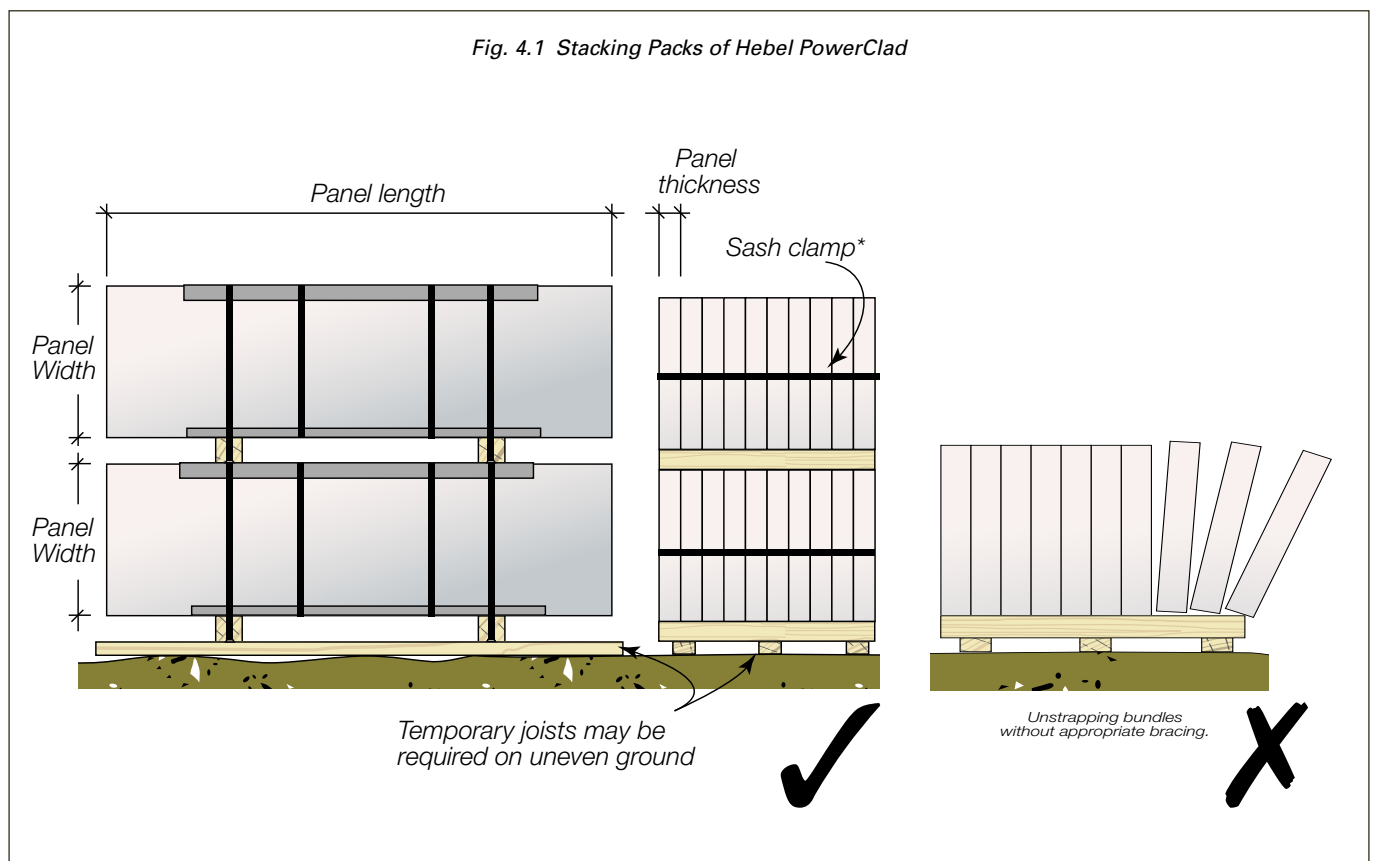
## Unstrapping Packs

Ensure appropriate bracing is installed to packs prior to removal of strapping to prevent panels from falling.

Panels can be held together with sash clamps, ratchet, straps or Hebel stabilising bars.



Fig. 4.1 Stacking Packs of Hebel PowerClad



## 4.2 Tools and Equipment

The basic tools required to assist in the installation of the Hebel PowerFloor are shown in Figure 4.1.

These may be purchased through CSR Hebel and include:

1. Stirrer
2. Trowel
3. Sanding float
4. Panel lifters
5. Levelling plane

Extra equipment will also be required and includes the following:

- Power drill (clutch driven)
- Power saw with metal or diamond tipped cutting blades
- Dust extraction system
- Sockets and bits for screws
- Personal Protective Equipment (PPE) such as goggles, face mask and P1/P2 dust masks, used when site cutting the panels

Fig 4.2 The Basic Tools and Equipment Requirements



# 4.3 Panel Installation

## Installation Procedures

CSR Hebel promotes and advocates a safety conscious work place at all times. To assist builders and contractors to maintain their safety standards, CSR Hebel has produced guidelines for the installation and handling of their products. Contact CSR Hebel for additional information.

## Mortars & Adhesives

The Hebel bagged mortar and adhesive should be prepared in accordance with instructions on the packaging.

## Damaged Panels

Chipped or damaged panels are to be repaired using Hebel Patching Mortar. Your Hebel supplier should be notified immediately of any panel damage or cracking that occurs during the handling of the panels. This damage may result in the panel being structurally inadequate, in which case it must be replaced.

## Panel Cutting

Hebel PowerFloor Panels to be cut with a circular saw fitted with a diamond tipped blade. The use of power tools may cause dust, which contains respirable crystalline silica, with the potential to cause bronchitis, silicosis and lung cancer after repeated and prolonged exposure. When using power or hand tools on Hebel products, wear a P1 or P2 respirator and eye protection. When cutting, routing or chasing Hebel products with power tools, use dust extraction equipment and wear hearing protection. Refer to CSR Hebel MSDS sheets. For further information, contact CSR Hebel or visit our website: **[www.hebelaustralia.com.au](http://www.hebelaustralia.com.au)**

Reinforcement exposed during cutting is to be coated with a liberal application of Fentak.

## 4.4 Panel Handling

### Manual Handling

CSR Hebel recommends using a trolley or other mechanical apparatus to move the panels around the work site. Manual handling, where people physically move a panel, should be kept to a minimum, with the weight being supported by an individual kept as small as possible. Any concerns regarding the weight to be handled should be discussed with the panel installing contractor.

To minimise the possibility of manual handling injuries, CSR Hebel suggests the following:

- Use mechanical aids, such as trolleys, fork lifts, cranes and levers, or team lifting to move panels.

- Keep the work place clean to reduce the risk of slips, trips and falls which can cause injury.
- Plan the sequence of installation to minimise panel movements and avoid awkward lifts.
- Keep the panels dry.
- Train employees in good lifting techniques to minimise the risk of injury.

Hebel products are cement-based, which may irritate the skin, resulting in itching and occasionally a red rash. The wearing of gloves and suitable clothing to reduce abrasion and irritation of the skin is recommended when handling Hebel products.



# Appendix A: Hebel PowerFloor Material Properties

## A.1 Manufacturing Tolerances

Length	± 5.0mm
Width	±1.5mm
Thickness	±1.5mm
Diagonals (Max.)	5mm
Edge straightness deviation (Max.)	1.5mm

## A.2 Hebel PowerFloor Physical Properties

- Hebel PowerFloor profile and nominal dimensions are shown in Section 3.3.
- Panel reinforcement is a single layer of steel mesh with 4 longitudinal wires of 4mm diameter.
- Nominal dry density = 510 kg/m<sup>3</sup>.
- Average working density = 688 kg/m<sup>3</sup> at 30% moisture content.
- Average service life density = 561 kg/m<sup>3</sup> at 10% moisture content.

## A.3 Hebel PowerFloor Strength Properties

- Characteristic Compressive Strength or AAC,  $f'_{cm}$  = 2.8 MPa.
- Average Compressive Strength of AAC = 4.0 MPa.
- Characteristic Modulus of Rupture,  $f'_{ut}$  = 0.60 MPa.

## A.4 Hebel PowerFloor Acoustic Properties

- Panel only with no plasterboard or other lining  $R_w$  = 36dB,  $R_w+C_{tr}$  = 33dB (refer to acoustic test ATF-676).

## A.5 Hebel PowerFloor Thermal Properties

- R-Value of PowerPanel with no plasterboard or other lining = 0.48 m<sup>2</sup>. K/W (6% moisture content).

## A.6 Fire Hazard Indices

Hebel products have BCA Group Number 1 and also the following early fire hazard indices, determined in accordance with AS1530.3:1990:

Ignitability Index	0
Spread of Flame Index	0
Heat Development Index	0
Smoke Development Index	0 - 1

## A.7 Fire Resistance Level (FRL) Ratings

For fire performance characteristics of Hebel PowerFloor, refer to Section 3.4 of this guide.



# Appendix B:

## Estimating Hebel PowerFloor

Following is a guide to assist in working out quantities and costs for the required components of the Hebel PowerFloor system.

### Step 1: Calculation of the Total Floor Area

First calculate the total floor area of the building, allowing for the panels to extend UNDER the external wall frames.

The easiest way for this to be calculated is to determine the overall wall length of the area being calculated, then minus the exterior wall material and cavity thickness. Below is a diagram of a house using the Hebel Low Rise External Wall System. This system gives an overall exterior wall thickness of 185mm (90mm stud frame, 20mm tophat batten and 75mm thick Hebel PowerPanel), so given the plan dimensions the area would be worked out as follows:

- $14.000 - 0.095 - 0.095 = 13.810$  m  
(0.095 = 75 mm Hebel PowerPanel and 20 mm tophat)
- $7.000 - 0.095 - 0.095 = 6.810$  m
- **Total Floor Area (TFA) =  $13.810 \times 6.810 = 94.0461$  m<sup>2</sup> (total area to the outside of the stud frame)**

### Step 2: Panel Waste

**This can be calculated in two ways:**

An accurate calculation by completing a detailed panel layout and measuring the amount of waste that will be generated due to the layout of the house. Or By applying a waste percentage to the Total Floor Area.

Generally allow an additional 5% of area. Therefore multiply the Total Floor Area by 1.05. This calculation gives you the total Adjusted Floor Area (TAFA).

### Step 3: Material Quantities

Now that the floor area has been worked out we can move on to working out the material quantities.

#### (A) Hebel PowerFloor Panels:

- Area of one panel =  $(1.8\text{m} \times 0.6\text{m}) = 1.08\text{m}^2$
- No. of panels = Total Adjusted Floor Area (TAFA)  $\div 1.08\text{m}^2$

#### (B) Screws

- Joists @ 450cts  
= 8 screws required per m<sup>2</sup> of floor
- Joists @ 600cts  
= 6 screws required per m<sup>2</sup> of floor
- Total screws  
= (6 or 8)  $\times$  Total Floor Area (TFA)

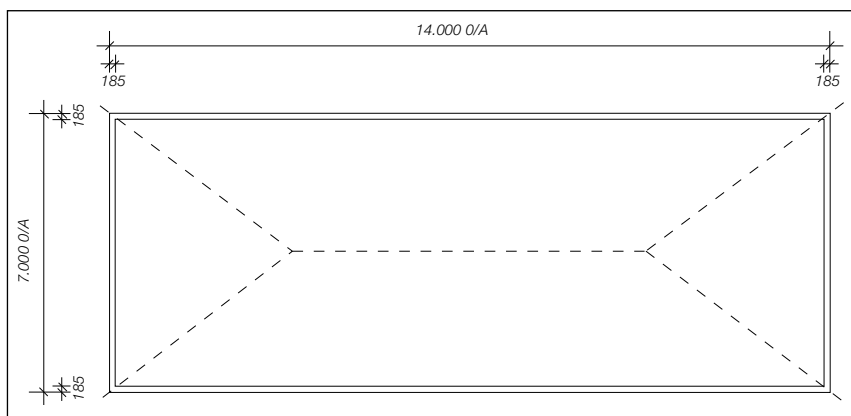
*Note: Packs come in 2 sizes, 100 or 250. Screws to be estimated based on the pack sizes.*

#### (C) Hebel Adhesive

- Each 20kg bag of Hebel Adhesive glues 20m<sup>2</sup> of floor area.
- Total bags = Total Floor Area (TFA)  $\div 20$

#### (D) Construction Adhesive

- Each tube of construction adhesive glues approx. 10 panels to the sub floor joists. This is  $10 \times 1.08\text{m}^2 = 10.8\text{m}^2$  of floor area.
- Total tubes of adhesive  
= Total Floor Area (TFA)  $\div 10.8$



# Appendix B: Estimating Hebel PowerFloor (Cont.)

Client Details				
Date				
Client Name				
Client Address				
Client Phone				
Client Fax				
Client Email				
	Total Floor Area (TFA) =			m <sup>2</sup>
	Total Adjusted Floor Area (TAFA) =	1.05 x TFA =		m <sup>2</sup>
Item		Quantity	Cost / Unit	Total Cost
Panels	TFA ÷ 1.08 =			\$
Screws (Joists @ 600)	TFA x 6 =		(250)	\$
OR (Joist @ 450)	TFA x 8 =			
			(100)	\$
Hebel Adhesive	TFA ÷ 20 =			\$
Construction Adhesive	TFA ÷ 10.8 =			\$
<b>TOTAL</b>				<b>\$</b>





## The better way to build

CSR HEBEL  
112 Wisemans Ferry Road  
Somersby NSW 2250  
Fax (02) 4340 3300

### Health & Safety

Information on any known health risks of our products and how to handle them safely is on their packaging and/or the documentation accompanying them. Additional information is listed in the Material Safety Data Sheet (MSDS). To obtain a copy of a MSDS, telephone 1800 807 668 or download from [www.hebelaustralia.com.au](http://www.hebelaustralia.com.au). Contractors are required by law to perform their own risk assessments before undertaking work. Hebel has sample Safe Work Method Statements (SWMS) to assist in this. To obtain a sample SWMS, refer also to the above sources.

### Performance & Certification

Hebel® products are manufactured in Australia by CSR Building Products.

A.B.N. 55 008 631 356. It is a manufacturer and supplier of Hebel Autoclaved Aerated Concrete (AAC) products. Because it is a manufacturer and supplier only, CSR does not employ people qualified as Accredited or Principal Certifiers. CSR is therefore unable to provide Construction Compliance Certificates or Statements of Compliance. CSR conducts appropriate testing of its products and systems to determine performance levels. These include structural, fire and acoustic tests. Testing is conducted and certified by appropriate specialists in these fields. When using Hebel products and systems in specific projects, such specialists should be consulted to ensure compliance with the Building Code of Australia and relevant Australian Standards.

### Other


The design of a wall, floor or fence system requires the services of professional consultants. This Design Guide has been prepared as a source of information to provide general guidance to those consultants – and in no way replaces the services of the professional consultant and relevant engineers designing the project.

No liability can therefore be accepted by CSR or other parties for the use of this Design Guide. Hebel products and systems undergo constant research and development to integrate new technology and reflect ongoing performance enhancement.

Hebel systems are also constantly reviewed so as to reflect any changes in legislative building requirements and or general developments in common building practice. Due to our commitment to continual development and improving our building systems.

We advise that all users of this manual: HEB1279 August 2011 should regularly check that this manual is current, and they are applying our latest design information.

The latest editions of our Design Guides and supplementary diagrams and technical data are always available on our website: [www.hebelaustralia.com.au](http://www.hebelaustralia.com.au)

 Hebel® is a registered trademark of the Xella group. CSR Building Products is an exclusive licensee of Xella.

CSR Hebel is a business of CSR Building Products Limited ABN 55 008 631 356. CSR, PowerPanel®, PowerClad®, Hebel Block®, PowerFloor®, Hebel Floor®, PowerFence®, PowerBase®, HighBuild®, are registered trademarks of CSR Building Products Limited.

## The better way to build

Hebel is a quality building product, and is backed by CSR Building Products Limited.

Further details on engineering and building with Hebel systems are available in the Hebel Design Guides and Technical Manual. To obtain a copy, or for further sales or technical assistance, please visit our website.

**Hebel website:**  
**[www.hebelaustralia.com.au](http://www.hebelaustralia.com.au)**

For sales enquiries or further information, please telephone us from anywhere in Australia:

# 1300 369 448

### Guarantee

Hebel guarantees the products manufactured by itself and the systems described in Hebel literature for 7 years, subject to the terms and conditions of the Hebel Guarantee which can be inspected in the Hebel website at [hebelaustralia.com.au](http://hebelaustralia.com.au). Hebel does not however guarantee the components, products or services, such as installation, supplied by others. Hebel recommends that only products, components and systems recommended by it be used.

### Disclaimer

The information presented herein is supplied in good faith and to the best of our knowledge was accurate at the time of preparation. The provision of this information should not be construed as a recommendation to use any of our products in violation of any patent rights or in breach of any statute or regulation. Users are advised to make their own determination as to the suitability of this information in relation to their particular purpose or specific circumstances. Since the information contained in this document may be applied under conditions beyond our control, no responsibility can be accepted by Hebel, or its staff for any loss or damage caused by any person acting or refraining from action as a result of misuse of this information.

### HEB1279 August 2011

Available from: